



# User Guide

AC1900 MU-MIMO Wi-Fi Router  
Archer A8

# Contents

About This Guide .....	1
<b>Chapter 1. Get to Know About Your Router .....</b>	<b>3</b>
1. 1. Product Overview.....	4
1. 2. Appearance .....	4
1. 2. 1.Top Panel .....	4
1. 2. 2.The Back Panel.....	6
<b>Chapter 2. Connect the Hardware .....</b>	<b>7</b>
2. 1. Position Your Router .....	8
2. 2. Connect Your Router.....	8
<b>Chapter 3. Log In to Your Router.....</b>	<b>11</b>
<b>Chapter 4. Set Up Internet Connection .....</b>	<b>13</b>
4. 1. Use Quick Setup Wizard .....	14
4. 2. Quick Setup Via TP-Link Tether App.....	15
4. 3. Manually Set Up Your Internet Connection .....	15
4. 4. Set Up the Router as an Access Point .....	18
4. 5. Set Up an IPv6 Internet Connection .....	18
<b>Chapter 5. TP-Link Cloud Service .....</b>	<b>21</b>
5. 1. Register a TP-Link ID.....	22
5. 2. Change Your TP-Link ID Information.....	22
5. 3. Manage the User TP-Link IDs .....	23
5. 3. 1.Add TP-Link ID to Manage the Router.....	24
5. 3. 2.Remove TP-Link ID(s) from Managing the Router.....	24
5. 4. Manage the Router via the TP-Link Tether App .....	25
<b>Chapter 6. Guest Network.....</b>	<b>26</b>
6. 1. Create a Network for Guests .....	27
6. 2. Customize Guest Network Options.....	28
<b>Chapter 7. Parental Controls .....</b>	<b>29</b>
7. 1. Setting Up Access Restrictions .....	30
<b>Chapter 8. QoS.....</b>	<b>33</b>

<b>Chapter 9. Network Security</b> .....	<b>35</b>
9.1. Protect the Network from Cyber Attacks .....	36
9.2. Access Control .....	36
9.3. IP & MAC Binding .....	38
9.4. ALG (Application Layer Gateway).....	40
<b>Chapter 10.NAT Forwarding</b> .....	<b>41</b>
10.1. Share Local Resources on the Internet by Port Forwarding .....	42
10.2. Open Ports Dynamically by Port Triggering.....	44
10.3. Make Xbox Online Games Run Smoothly by UPnP .....	45
10.4. Make Applications Free from Port Restriction by DMZ .....	46
<b>Chapter 11.Customize Your Network Settings</b> .....	<b>48</b>
11.1. Change the LAN Settings .....	49
11.2. Configure to Support IPTV Service.....	49
11.3. Specify DHCP Server Settings .....	50
11.4. Set Up a Dynamic DNS Service Account .....	51
11.5. Create Static Routes.....	53
11.6. Specify Wireless Settings.....	55
11.7. Schedule Your Wireless Function .....	57
11.8. Use WPS for Wireless Connection .....	57
11.8.1.Connect via the Client's PIN .....	58
11.8.2.Connect via the Router's PIN .....	58
11.8.3.Push the WPS Button .....	58
11.9. Advanced Wireless Settings .....	59
<b>Chapter 12.Manage the Router</b> .....	<b>61</b>
12.1. Upgrade the Firmware .....	62
12.1.1.Online Upgrade .....	62
12.1.2.Local Upgrade .....	62
12.2. Backup and Restore Configuration Settings.....	63
12.3. Change the Login Password .....	64
12.4. Local Management .....	65
12.5. Remote Management.....	66
12.6. View System Log .....	68
12.7. Test the Network Connectivity .....	69
12.8. Set Up System Time & Language .....	70
12.9. Set the Router to Reboot Regularly.....	72
12.10. Control the LED.....	73
<b>FAQ</b> .....	<b>75</b>







# About This Guide

This guide is a complement of Quick Installation Guide. The Quick Installation Guide instructs you on quick internet setup, and this guide provides details of each function and shows you the way to configure these functions appropriate to your needs.

When using this guide, please note that features available of the router may vary by model and software version. Router's availability may also vary by region or ISP. All images, steps, and descriptions in this guide are only examples and may not reflect your actual experience.

## Conventions

In this guide the following conventions are used:

Convention	Description
<u>Underlined</u>	Underlined words or phrases are hyperlinks. You can click to redirect to a website or a specific section.
Teal	Contents to be emphasized and texts on the web page are in teal, including the menus, items, buttons, etc.
>	The menu structures to show the path to load the corresponding page. For example, <a href="#">Advanced</a> > <a href="#">Wireless</a> > <a href="#">MAC Filtering</a> means the MAC Filtering function page is under the Wireless menu that is located in the Advanced tab.
 <b>Note:</b>	Ignoring this type of note might result in a malfunction or damage to the device.
 <b>Tips:</b>	Indicates important information that helps you make better use of your device.
Symbols on the web page	<ul style="list-style-type: none"><li> Click to edit the corresponding entry.</li><li> Click to delete the corresponding entry.</li><li> Click to enable or disable the corresponding entry.</li><li> Click to view more information about items on the page.</li></ul>

\*Maximum wireless signal rates are the physical rates derived from IEEE Standard 802.11 specifications. Actual wireless data throughput and wireless coverage are not guaranteed and will vary as a result of network conditions, client limitations, and environmental factors, including building materials, obstacles, volume and density of traffic, and client location.

\*Use of MU-MIMO requires clients to also support MU-MIMO.

## More Info

- The latest software, management app and utility can be found at [Download Center](#) at <https://www.tp-link.com/support>.
- The Quick Installation Guide can be found where you find this guide or inside the package of the router.
- Specifications can be found on the product page at <https://www.tp-link.com>.

- A TP-Link Community is provided for you to discuss our products at <https://community.tp-link.com>.
- Our Technical Support contact information can be found at the [Contact Technical Support](#) page at <https://www.tp-link.com/support>.

## Chapter 1

---

# Get to Know About Your Router

---

This chapter introduces what the router can do and shows its appearance.

It chapter contains the following sections:

- [Product Overview](#)
- [Appearance](#)

## 1.1. Product Overview

The TP-Link router is designed to fully meet the need of Small Office/Home Office (SOHO) networks and users demanding higher networking performance. The powerful antennas ensure continuous Wi-Fi signal to all your devices while boosting widespread coverage throughout your home, and the built-in Ethernet ports supply high-speed connection to your wired devices.

Moreover, it is simple and convenient to set up and use the TP-Link router due to its intuitive web interface and the powerful Tether app.

## 1.2. Appearance

### 1.2.1. Top Panel



The router's LEDs (view from left to right) are located on the front. You can check the router's working status by following the LED Explanation table.



### LED Explanation

- Router Mode





LED	Status	Indication
⏻ (Power)	On	The system has started up successfully.
	Flashing	The system is starting up or the firmware is being upgraded. Do not disconnect or power off your router.
	Off	Power is off.
📶 (2.4GHz Wireless)	On	The 2.4GHz wireless band is enabled.
	Off	The 2.4GHz wireless band is disabled.

## LED Explanation

### • Router Mode

LED	Status	Indication
 (5GHz Wireless)	On	The 5GHz wireless band is enabled.
	Off	The 5GHz wireless band is disabled.
 (LAN)	On	At least one powered-on device is connected to the router's LAN port.
	Off	No powered-on device is connected to the router's LAN port.
 (Internet)	Green On	Internet service is available.
	Orange On	The router's Internet port is connected, but the internet service is not available.
	Off	The router's Internet port is unplugged.

### • Access Point Mode

LED	Status	Indication
 (Power)	On	The system has started up successfully.
	Flashing	The system is starting up or the firmware is being upgraded. Do not disconnect or power off your router.
	Off	Power is off.
 (2.4GHz Wireless)	On	The 2.4GHz wireless band is enabled.
	Off	The 2.4GHz wireless band is disabled.
 (5GHz Wireless)	On	The 5GHz wireless band is enabled.
	Off	The 5GHz wireless band is disabled.
 (LAN)	On	At least one powered-on device is connected to the router's LAN port.
	Off	No powered-on device is connected to the router's LAN port.
 (Internet)	Green On	Internet service is available.
	Off	The router's Internet port is unplugged.



## 1.2.2. The Back Panel



The following parts (view from left to right) are located on the back panel.

### Button and Port Explanation

Item	Description
Power Port	For connecting the router to a power socket via the provided power adapter.
Power On/Off Button	Press this button to power on or off the router.
Reset Button	Press and hold the button until all LEDs turn on to reset the router to its factory default settings.
WPS/Wi-Fi Button	Press the button for 1 second, and immediately press the WPS button on your client to start the WPS process.
	Press and hold the button for 5 seconds to turn on or off the wireless function of your router.
Internet Port	For connecting to a DSL/Cable modem, or an Ethernet jack.
Ethernet Ports (1/2/3/4)	For connecting your PC or other wired devices to the router.
Antennas	Used for wireless operation and data transmit. Upright them for the best Wi-Fi performance.

## Chapter 2

---

# Connect the Hardware

---

This chapter contains the following sections:

- [Position Your Router](#)
- [Connect Your Router](#)

## 2.1. Position Your Router

- The product should not be located in a place where it will be exposed to moisture or excessive heat.
- Place the router in a location where it can be connected to multiple devices as well as to a power source.
- Make sure the cables and power cord are safely placed out of the way so they do not create a tripping hazard.
- The router can be placed on a shelf or desktop.
- Keep the router away from devices with strong electromagnetic interference, such as Bluetooth devices, cordless phones and microwaves.

## 2.2. Connect Your Router

Before you start, turn off your modem, if any, and remove the backup battery if it has one. Then place the router horizontally and orient the antennas vertically.

■ **Note:** If you already have a router and want to configure this new router as an access point to extend your network, refer to [Set Up the Router as an Access Point](#).

Follow the steps below to connect your router.

If your internet connection is through an Ethernet cable directly from the wall instead of through a DSL / Cable / Satellite modem, connect the Ethernet cable to the router's Internet port, and then follow steps 4 and 5 to complete the hardware connection.

1. Turn off the modem, and remove the backup battery if it has one.
2. Connect the modem to the router's **Internet port** with an Ethernet cable.
3. Turn on the modem, and then wait about **2 minutes** for it to restart.

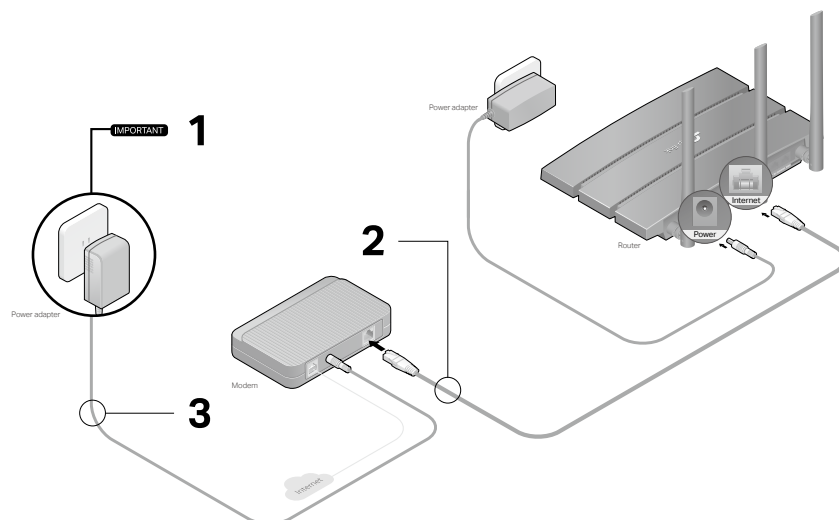

4. Connect the power adapter to the router and turn on the router.
5. Verify that the following LEDs are on and solid to confirm the hardware is connected.

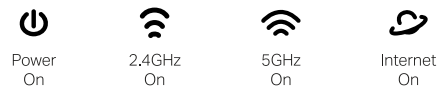

**Note:**

Note: If the 2.4GHz LED and 5GHz LED are off, press and hold the WPS/Wi-Fi button on the back for more than 5 seconds, then release the button. Both the LEDs should turn solid on.

6. Connect your computer to the router.

• **Method 1: Wired**

Turn off the Wi-Fi on your computer and connect your computer to the router's LAN port as shown below.

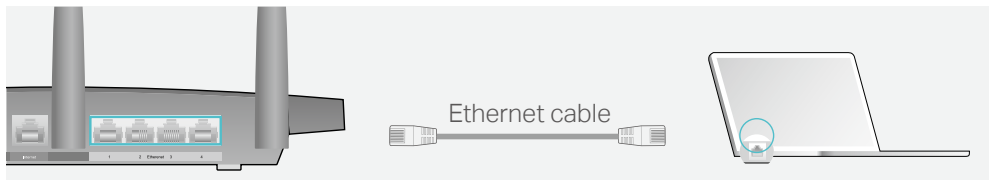

• **Method 2: Wirelessly**

- 1) Find the SSID (Network Name) and Wireless Password printed on the label at the bottom of the router.
- 2) Click the network icon of your computer or go to Wi-Fi Settings of your smart device, and then select the SSID to join the network.

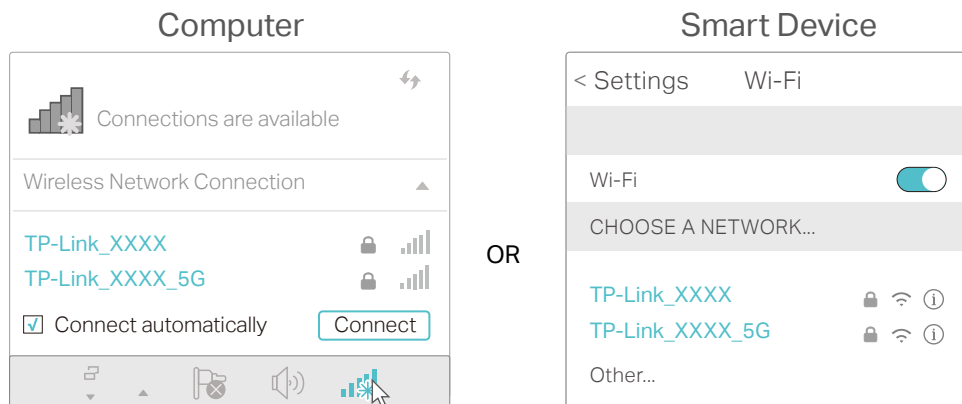

• **Method 3: Use the WPS button**

Wireless devices that support WPS, including Android phones, tablets, and most USB network cards, can be connected to your router through this method.

**Note:**

- WPS is not supported by iOS devices.

- The WPS function cannot be configured if the wireless function of the router is disabled. Also, the WPS function will be disabled if your wireless encryption is WEP. Please make sure the wireless function is enabled and is configured with the appropriate encryption before configuring the WPS.

- 1) Tab the WPS icon on the device's screen. Here we take an Android phone for instance.
- 2) Within two minutes, press the WPS button on your router.

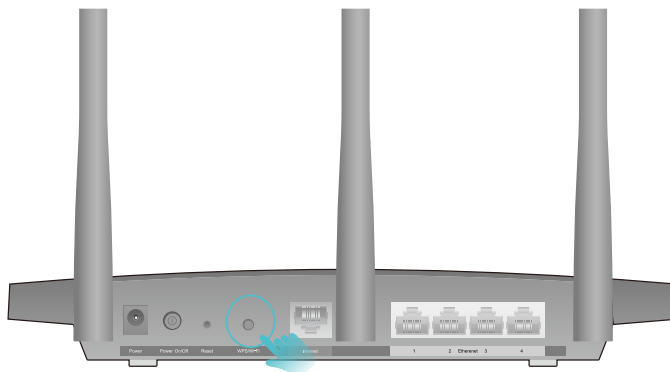
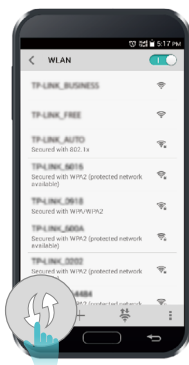

## Chapter 3

---

# Log In to Your Router

---

With a web-based utility, it is easy to configure and manage the router. The web-based utility can be used on any Windows, Mac OS or UNIX OS with a Web browser, such as Microsoft Internet Explorer, Mozilla Firefox or Apple Safari.

Follow the steps below to log in to your router.

1. Set up the TCP/IP Protocol in [Obtain an IP address automatically](#) mode on your computer.
2. Visit <http://tplinkwifi.net>, and create a login password for secure management purposes. Then click [Let's Get Started](#) to log in.

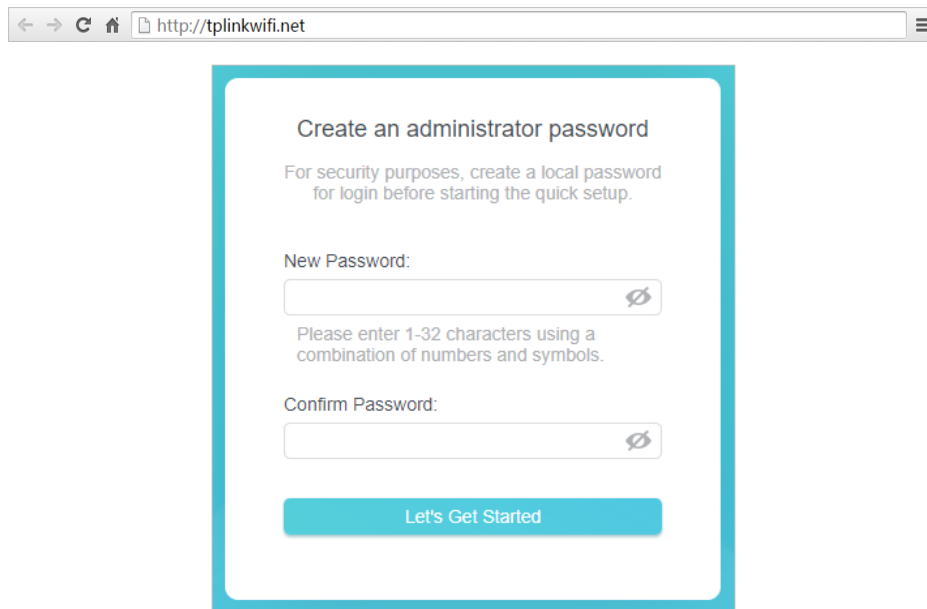

The image shows a web browser window with the address bar displaying <http://tplinkwifi.net>. The main content area is a white box with a teal border containing the following text and form elements:

**Create an administrator password**

For security purposes, create a local password for login before starting the quick setup.

New Password:

  
Please enter 1-32 characters using a combination of numbers and symbols.

Confirm Password:

[Let's Get Started](#)

**Note:**

- If the login window does not appear, please refer to the [FAQ](#) Section.
- If you have registered a TP-Link ID and bound your cloud router to it, the login password you created here will be invalid. Please log in to the cloud router using your TP-Link ID.

## Chapter 4

---

# Set Up Internet Connection

---

This chapter introduces how to connect your router to the internet. The router is equipped with a web-based Quick Setup wizard. It has necessary ISP information built in, automates many of the steps and verifies that those steps have been successfully completed. Furthermore, you can also set up an IPv6 connection if your ISP provides IPv6 service.

It contains the following sections:

- [Use Quick Setup Wizard](#)
- [Quick Setup Via TP-Link Tether App](#)
- [Manually Set Up Your Internet Connection](#)
- [Set Up the Router as an Access Point](#)
- [Set Up an IPv6 Internet Connection](#)



## 4.1. Use Quick Setup Wizard

The Quick Setup Wizard will guide you to set up your router.

☞ **Tips:**

If you need the IPv6 internet connection, please refer to the section of [Set Up an IPv6 Internet Connection](#).

Follow the steps below to set up your router.

1. Visit <http://tplinkwifi.net>, and log in with the password you set for the router.
2. Follow the step-by-step instructions to complete Quick Setup configuration or go to [Advanced](#) > [Quick Setup](#) for configuration to connect your router to the internet. Then follow the step-by-step instructions to connect your router to the internet.

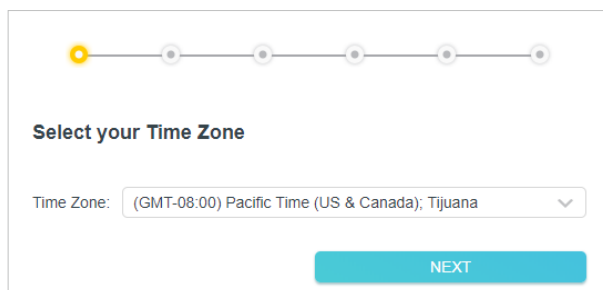

3. To enjoy a more complete service from TP-Link (remote management, TP-Link DDNS, and more.), log in with your TP-Link ID or click [Sign Up Now](#) to get one. Then follow the instructions to bind the cloud router to your TP-Link ID.

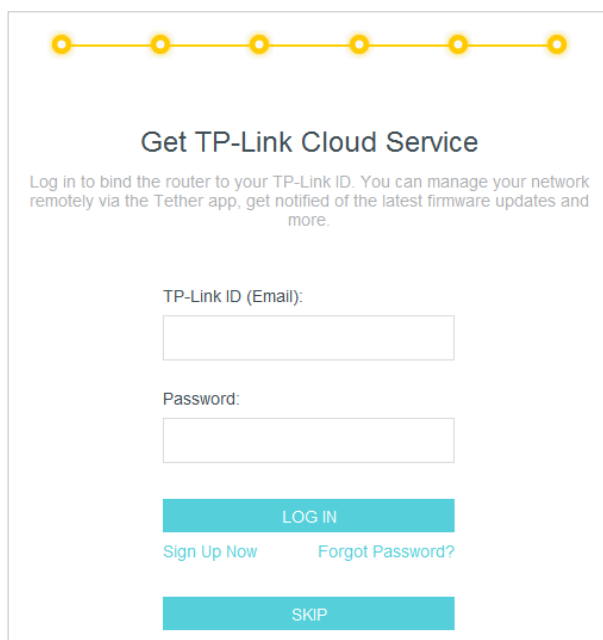

📌 **Note:**

- To learn more about the TP-Link Cloud service, please refer to the [TP-Link Cloud Service](#) section.
- If you do not want to register a TP-Link ID now, you may click [Skip](#) to proceed.
- If you have changed the preset wireless network name (SSID) and wireless password during the Quick Setup process, all your wireless devices must use the new SSID and password to connect to the router.

## 4.2. Quick Setup Via TP-Link Tether App

The Tether app runs on iOS and Android devices, such as smartphones and tablets.

1. Launch the Apple App Store or Google Play store and search “TP-Link Tether” or simply scan the QR code to download and install the app.



2. Launch the Tether app and log in with your TP-Link ID.

■ **Note:** If you don't have an account, click Sign Up to create one first.

3. Connect your device to the router's wireless network.
4. Tap the + button and select **Router** > **Wireless Router**. Follow the steps to complete the setup and connect to the internet.

## 4.3. Manually Set Up Your Internet Connection

In this part, you can check your current internet connection settings. You can also modify the settings according to the service information provided by your ISP.

Follow the steps below to check or modify your internet connection settings.

1. Visit <http://tplinkwifi.net>, and log in with your TP-Link ID or the password you set for the router.
2. Go to **Internet**.
3. Select your internet connection type from the drop-down list.

**Internet**

Set up an internet connection with the service information provided by your ISP (internet service provider).

Internet Connection Type:  ▼

Select this type if your ISP doesn't provide any information for internet connection.

4. Follow the instructions on the page to continue the configuration. Parameters on the figures are just used for demonstration.
  - 1) If you choose **Dynamic IP**, you need to select whether to clone the MAC address. Dynamic IP users are usually equipped with a cable TV or fiber cable.

**Internet**

Set up an internet connection with the service information provided by your ISP (internet service provider).

Internet Connection Type:  

Select this type if your ISP doesn't provide any information for internet connection.

Set the MAC address of your router. Use the default address unless your ISP allows internet access from only a specific MAC address.

**MAC Clone**

Router MAC Address:  

- 2) If you choose **Static IP**, enter the information provided by your ISP in the corresponding fields.

**Internet**

Set up an internet connection with the service information provided by your ISP (internet service provider).

Internet Connection Type:  

Select this type if your ISP provides specific IP parameters.

IP Address:

Subnet Mask:

Default Gateway:

Primary DNS:

Secondary DNS:  (Optional)

- 3) If you choose **PPPoE**, enter the **username** and **password** provided by your ISP. PPPoE users usually have DSL cable modems.

**Internet**

Set up an internet connection with the service information provided by your ISP (internet service provider).

Internet Connection Type:  

Select this type if your ISP only provides a username and password.

Username:

Password:  

- 4) If you choose **L2TP**, enter the **username** and **password** and choose the **Secondary Connection** provided by your ISP. Different parameters are needed according to the Secondary Connection you have chosen.

**Internet**

Set up an internet connection with the service information provided by your ISP (internet service provider).

Internet Connection Type:  ▼

Select this type if your ISP provides L2TP VPN server information and an account. Some ISPs also provide specific IP parameters.

Username:

Password:  

Dynamic IP

Static IP

Server IP/Domain Name:

- 5) If you choose **PPTP**, enter the **username** and **password**, and choose the **Secondary Connection** provided by your ISP. Different parameters are needed according to the Secondary Connection you have chosen.

**Internet**

Set up an internet connection with the service information provided by your ISP (internet service provider).

Internet Connection Type:  ▼

Select this type if your ISP provides PPTP VPN server information and an account. Some ISPs also provide specific IP parameters.

Username:

Password:  

Dynamic IP

Static IP

Server IP/Domain Name:

5. Click **Save**.

 **Tips:**

- If you use **Dynamic IP** and **PPPoE** and you are provided with any other parameters that are not required on the page, please go to **Advanced > Network > Internet** to complete the configuration.
- If you still cannot access the internet, refer to the [FAQ](#) section for further instructions.

## 4.4. Set Up the Router as an Access Point

The router can work as an access point, transforming your existing wired network to a wireless one.

1. Visit <http://tplinkwifi.net>, and log in with your TP-Link ID or the password you set for the router.
2. Go to **Advanced** > **Operation Mode**, select **Access Point** and click **Save**. The router will reboot and switch to Access Point mode.

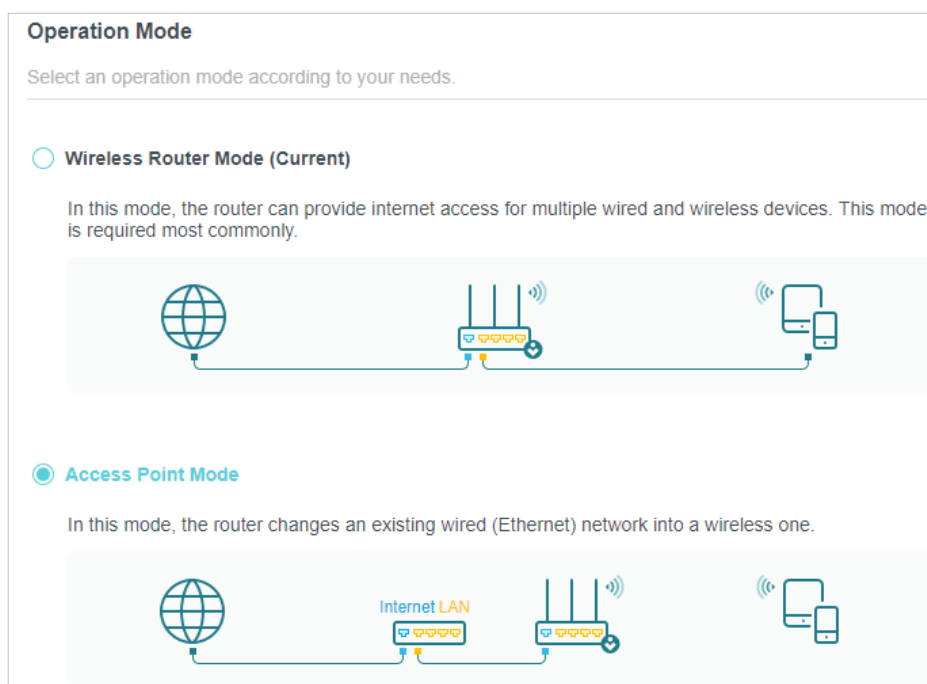

3. After rebooting, connect the router to your existing wired router via an Ethernet cable.
4. Log in again to the web management page <http://tplinkwifi.net>, and go to **Advanced** > **Quick Setup**.
5. Configure your wireless settings and click **Next**.
6. Confirm the information and click **Save**. Now, you can enjoy Wi-Fi.

☞ **Tips:**

- Functions, such as Parental Controls, QoS and NAT Forwarding, are not supported in the Access Point mode.
- Functions, such as Guest Network, are the same as those in the Router mode.

## 4.5. Set Up an IPv6 Internet Connection

Set up an IPv6 connection if your ISP provides IPv6 service.

1. Visit <http://tplinkwifi.net>, and log in with your TP-Link ID or the password you set for the router.
2. Go to **Advanced** > **IPv6**.

**IPv6**

Set up an IPv6 connection if your ISP provides IPv6 service.

---

Mode: Disable ▼

Disable

Router

Pass-Through (Bridge)

### 3. Select the mode provided by your ISP to enable IPv6 connection.

📌 **Tips:**

If you do not know what your internet connection mode is, contact your ISP or judge according to the already known information provided by your ISP.

- **Pass-Through (Bridge):** Select **Pass-Through (Bridge)** and click **Save**.

**IPv6**

Set up an IPv6 connection if your ISP provides IPv6 service.

---

Mode: Pass-Through (Bridge) ▼

Select this type if your ISP uses Pass-Through (Bridge) network deployment.

• **Router:**

#### 1) Select **Router** mode.

**IPv6**

Set up an IPv6 connection if your ISP provides IPv6 service.

---

Mode: Router ▼

#### 2) Configure the WAN connection.

**WAN**

Configure the WAN connection based on your network typology.

---

WAN Connection Type: Normal ▼

Get IPv6 Address: Auto ▼

Manually set DNS server

Link-Local Address:

Global Address:

Gateway:

Primary DNS:

Secondary DNS:

**Notes:**

1. If you do not know what your internet connection mode is, contact your ISP or judge according to the already known information provided by your ISP.
2. If your ISP provides two separate accounts for the IPv4 and IPv6 connections, manually enter the username and password for the IPv6 connection.

**3) Keep the default settings of LAN.**

**LAN**

Configure the LAN IPv6 address of the router.

---

Enable Prefix Delegation

Link-Local Address:

Prefix:

[Connect](#)

[Disconnect](#)

**4) Click [Connect](#) then click [Save](#) to apply your settings.****Tips:**

Visit the [FAQ](#) section if there is no internet connection.

## Chapter 5

---

# TP-Link Cloud Service

---

TP-Link Cloud service provides a better way to manage your cloud devices. Log in to your router with a TP-Link ID, and you can easily monitor and manage your home network when you are out and about via the Tether app. To ensure that your router stays new and gets better over time, the TP-Link Cloud will notify you when an important firmware upgrade is available. Surely you can also manage multiple TP-Link Cloud devices with a single TP-Link ID.

This chapter introduces how to register a new TP-Link ID, bind or unbind TP-Link IDs to manage your router, and the Tether app with which you can manage your home network no matter where you may find yourself.

It contains the following sections:

- [Register a TP-Link ID](#)
- [Change Your TP-Link ID Information](#)
- [Manage the User TP-Link IDs](#)
- [Manage the Router via the TP-Link Tether App](#)



## 5.1. Register a TP-Link ID

If you have skipped the registration during the Quick Setup process, you can:

1. Visit <http://tplinkwifi.net>, and log in with the password you set for the router.
2. Go to [Advanced > TP-Link ID](#) or click [TP-Link ID](#) on the very top of the page.
3. Click [Sign Up](#) and follow the instructions to register a TP-Link ID.

**TP-Link ID**

Log in to bind the router to your TP-Link ID. You can remotely manage your network via the Tether app, and more.

TP-Link ID (Email):

Password:

[Log In](#)

[Sign Up](#) [Forgot Password?](#)

4. After activating your TP-Link ID, come back to the TP-Link ID page to log in. The TP-Link ID used to log in to the router for the first time will be automatically bound as an [Admin](#).

**Note:**

- To learn more about the [Admin](#) and [User](#) TP-Link ID, refer to [Manage the Router via the TP-Link Tether App](#).
- Once the router is bound to your TP-Link ID, you need to log in to the router with the TP-Link ID.
- Once you have registered a TP-Link ID on the web management page, you can only register another TP-Link ID via the Tether APP. Please refer to [Manage the Router via the TP-Link Tether App](#) to install the app.
- If you want to unbind the admin TP-Link ID from your router, please go to [Advanced > TP-Link ID](#), and click [Unbind](#) in the [Device Information](#) section.

## 5.2. Change Your TP-Link ID Information

Follow the steps below to change your email address and password of your TP-Link ID as needed.

1. Visit <http://tplinkwifi.net>, and log in with your TP-Link ID.
2. Go to [Advanced > TP-Link ID](#), and focus on the [Account Information](#) section.

- **To change your email address:**

1. Click  behind the Email.
2. Enter the password of your TP-Link ID, then a new email address. And click [Save](#).

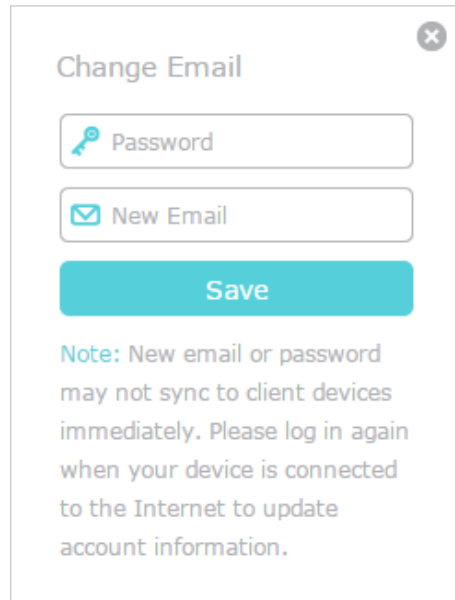

The image shows a 'Change Email' dialog box with a close button (X) in the top right corner. It contains two input fields: 'Password' with a key icon and 'New Email' with an envelope icon. Below the fields is a teal 'Save' button. A note at the bottom states: 'Note: New email or password may not sync to client devices immediately. Please log in again when your device is connected to the Internet to update account information.'

- **To change your password:**

1. Click  behind the Password.
2. Enter the current password, then a new password twice. And click [Save](#).

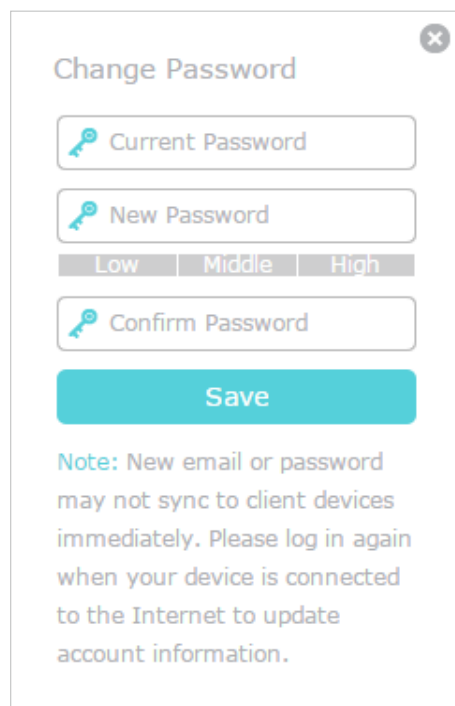

The image shows a 'Change Password' dialog box with a close button (X) in the top right corner. It contains three input fields: 'Current Password', 'New Password', and 'Confirm Password', each with a key icon. Below the 'New Password' field are three tabs labeled 'Low', 'Middle', and 'High'. Below the fields is a teal 'Save' button. A note at the bottom states: 'Note: New email or password may not sync to client devices immediately. Please log in again when your device is connected to the Internet to update account information.'

### 5.3. Manage the User TP-Link IDs

The TP-Link ID used to log in to the router for the first time will be automatically bound as the [Admin](#) account. An admin account can add or remove other TP-Link IDs to or

from the same router as **Users**. All accounts can monitor and manage the router locally or remotely, but user accounts cannot:

- Reset the router to its factory default settings either on the web management page or in the Tether app.
- Add/remove other TP-Link IDs to/from the router.

### 5.3.1. Add TP-Link ID to Manage the Router

1. Visit <http://tplinkwifi.net>, and log in with your TP-Link ID.
2. Go to **Advanced > TP-Link ID**, and focus on the **Bound Accounts** section.
3. Click **+ Bind**, enter another TP-Link ID as needed and click **Save**.

**Note:** If you need another TP-Link ID, please register a new one via the Tether app. Refer to [Manage the Router via the TP-Link Tether App](#) to install the app and register a new TP-Link ID.

4. The new TP-Link ID will be displayed in the Bound Accounts table as a **User**.

Bound Accounts				
<span style="color: teal;">+</span> Bind <span style="color: red;">-</span> Unbind				
<input type="checkbox"/>	ID	Email	Binding Date	Role
<input type="checkbox"/>	1	admin_123@tplink.com	2023-10-27	Admin
<input type="checkbox"/>	2	admin_123@tplink.com	2023-10-27	User

### 5.3.2. Remove TP-Link ID(s) from Managing the Router

1. Visit <http://tplinkwifi.net>, and log in with your TP-Link ID.
2. Go to **Advanced > TP-Link ID**, and focus on the **Bound Accounts** section.
3. Tick the checkbox(es) of the TP-Link ID(s) you want to remove and click **Unbind**.

Bound Accounts				
<a href="#">+ Bind</a> <a href="#">- Unbind</a>				
<input type="checkbox"/>	ID	Email	Binding Date	Role
<input type="checkbox"/>	1	*****@****.com	****/****/****	Admin
<input checked="" type="checkbox"/>	2	*****@****.com	****/****/****	User

## 5.4. Manage the Router via the TP-Link Tether App

The Tether app runs on iOS and Android devices, such as smartphones and tablets.

1. Launch the Apple App Store or Google Play store and search “TP-Link Tether” or simply scan the QR code to download and install the app.



2. Launch the Tether app and log in with your TP-Link ID.

**Note:** If you don't have an account, click Sign Up to create one first.

3. Select the model of your router and manage it as needed.

## Chapter 6

---

# Guest Network

---

This function allows you to provide Wi-Fi access for guests without disclosing your main network. When you have guests in your house, apartment, or workplace, you can create a guest network for them. In addition, you can customize guest network options to ensure network security and privacy.

It contains the following sections:

- [Create a Network for Guests](#)
- [Customize Guest Network Options](#)

## 6.1. Create a Network for Guests

1. Visit <http://tplinkwifi.net>, and log in with your TP-Link ID or the password you set for the router.
2. Go to **Advanced > Wireless > Guest Network** or click **Wireless** on the top page. Locate the **Guest Network** section.
3. Create a guest network as needed.
  - 1) Tick the **Enable** checkbox for the 2.4GHz or 5GHz wireless network.
  - 2) Customize the SSID. Don't select **Hide SSID** unless you want your guests to manually input the SSID for guest network access.
  - 3) Select the **Security** type.
    - If **No security** is selected, no password is needed to access your guest network.
    - If **WAP/WPA2-Personal** is selected, customize your own password.

**Guest Network**

Enable the wireless bands you want your guests to use and complete the related information.

**2.4GHz:**  Enable [Sharing Network](#)

Network Name (SSID):   Hide SSID

**5GHz:**  Enable [Sharing Network](#)

Network Name (SSID):   Hide SSID

Security:  ▼

Password:

4. Click **Save**. Now your guests can access your guest network using the SSID and password you set!
5. You can also click **Sharing Network** to share the SSID and password to your guests.

**2.4GHz:**  Enable [Sharing Network](#)

Network Name (SSID):

**5GHz:**  Enable

Network Name (SSID):

Security:

QR Code: 

SSID:  TP-Link\_Guest\_01D8

Password: 12345678

[Save Picture](#)

### Tips:

To view guest network information, go to **Network Map** and locate the **Guest Network** section. You can turn on or off the guest network function conveniently.

## 6.2. Customize Guest Network Options

1. Visit <http://tplinkwifi.net>, and log in with your TP-Link ID or the password you set for the router.
2. Go to [Advanced](#) > [Wireless](#) > [Guest Network](#). Locate the [Guest Permissions](#) section.
3. Customize guest network options according to your needs.

**Guest Permissions**

Control the data that guests can access.

---

Allow guests to see each other

Allow guests to access your local network

- [Allow guests to see each other](#)

Tick this checkbox if you want to allow the wireless clients on your guest network to communicate with each other via methods such as network neighbors and Ping.

- [Allow guests to access your local network](#)

Tick this checkbox if you want to allow the wireless clients on your guest network to communicate with the devices connected to your router's LAN ports or main network via methods such as network neighbors and Ping.

4. Click [Save](#). Now you can ensure network security and privacy!

## Chapter 7

---

# Parental Controls

---

This function allows you to block inappropriate, explicit and malicious websites, and control access to specified websites at specified time.



## 7.1. Setting Up Access Restrictions

### I want to:

Block access to inappropriate online content for my child's devices, restrict internet access to 2 hours every day and block internet access during bed time (10 PM to 7 AM) on weekdays.

### How can I do that?

1. Visit <http://tplinkwifi.net>, and log in with your TP-Link ID or the password you set for the router.
2. Go to [Advanced > Parental Controls](#).
3. Click [+](#) **Add** to create a profile for a family member.
4. Add basic profile information.

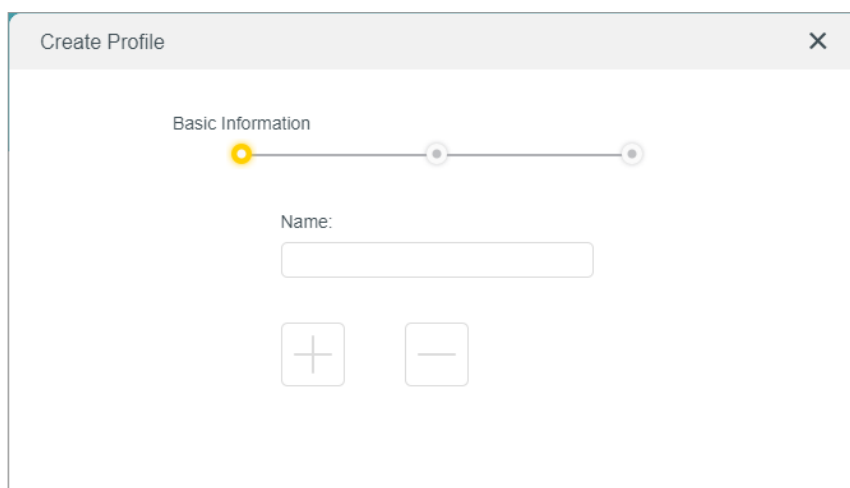

- 1) Enter a **Name** for the profile to make it easier to identify.
- 2) Click [+](#) to select the devices that belong to this profile. Access restrictions will be applied to these devices. Click **ADD** when finished.  
**Note:** Only devices that have previously been connected to your router's network are listed here. If you are unable to find the device you want to add, connect it to your network and then try again.
- 3) Click **Next**.
5. Customize the **Blocked Content** according to your needs for this profile.

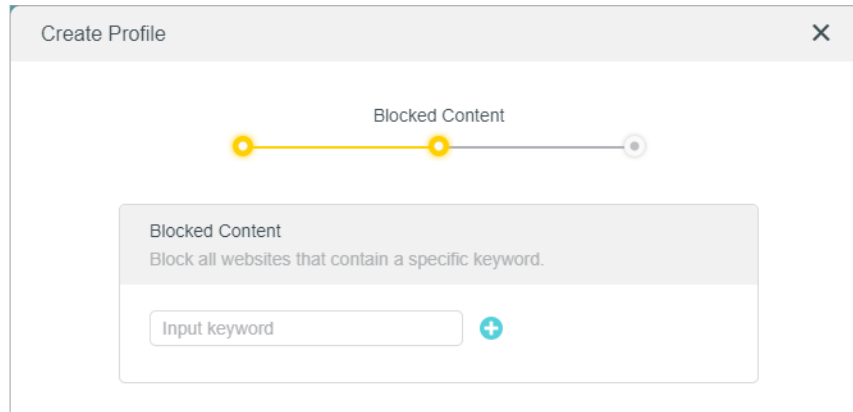

- 1) Enter a keyword (for example, "Facebook") or a URL (for example, "www.facebook.com"). All websites containing the keywords will be blocked.
- 2) Click [Next](#).

6. Set time restrictions on internet access.

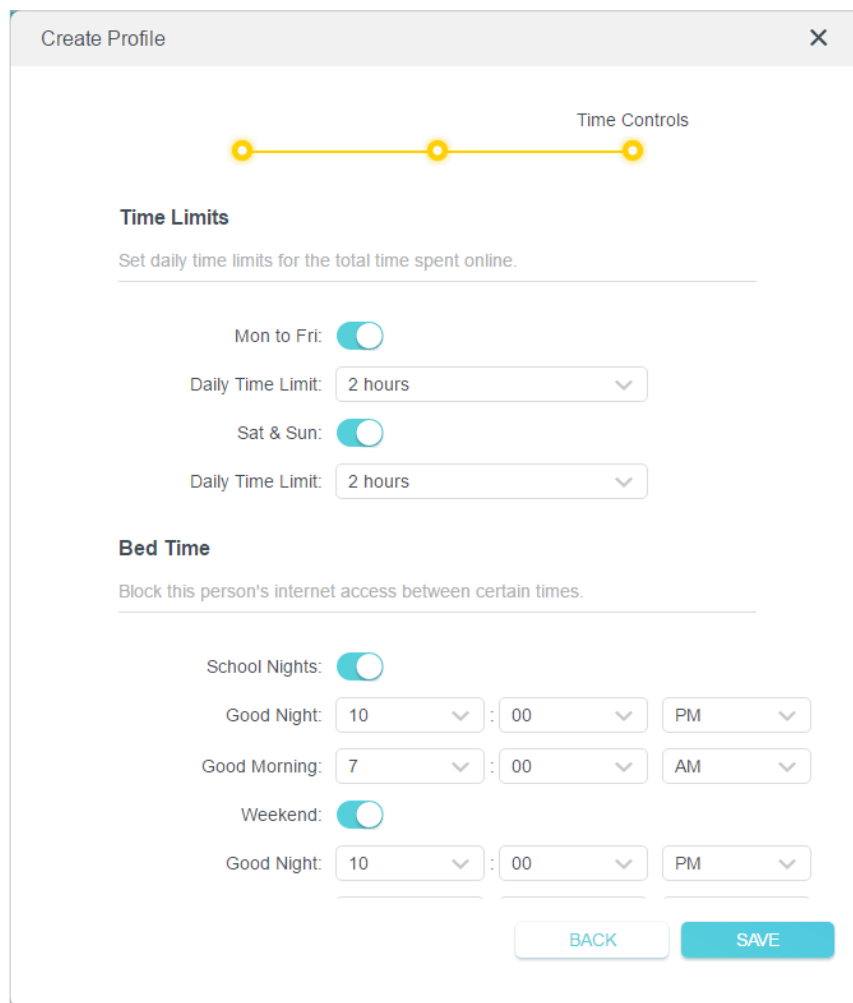

- 1) Enable [Time Limits](#) on Monday to Friday and Saturday & Sunday then set the allowed online time to 2 hours each day.

- 2) Enable **Bed Time** and use the up/down arrows or enter times in the fields. Devices under this profile will be unable to access the internet during this time period.

■ Note: School Nights refer to Sunday, Monday, Tuesday, Wednesday and Thursday nights.

- 3) Click **Save**.

## **Done!**

The amount of time your child spends online is controlled and inappropriate content is blocked on their devices.

## Chapter 8

---

# QoS

---

This chapter introduces how to create a QoS (Quality of Service) rule to specify prioritization of traffic and minimize the impact caused when the connection is under heavy load.

## I want to:

Specify priority levels for some devices or applications.

For example, I have several devices that are connected to my wireless network. I would like to set an intermediate speed on the internet for my computer for the next 2 hours.

## How can I do that?

### 1. Enable QoS and set bandwidth allocation.

- 1) Visit <http://tplinkwifi.net>, and log in with your TP-Link ID or the password you set for the router.
- 2) Go to [Advanced](#) > [QoS](#) > [Global Settings](#).
- 3) Tick to enable [QoS](#).  
 Note: QoS and NAT Boost cannot be enabled at the same time. To disable NAT Boost, go to [Advanced](#) > [Network](#) > [Internet](#) > [NAT](#).
- 4) Input the maximum upload and download bandwidth provided by your internet service provider. 1Mbps equal s to 1000Kbps.
- 5) Click [SAVE](#).

**Global Settings**

Prioritize the Internet traffic of specific device to guarantee a faster connection.

QoS:  Enable

Upload Bandwidth:  Mbps

Download Bandwidth:  Mbps

2. In the [Device Priority](#) section, find your computer and toggle on [Priority](#). Click the entry in the [Timing](#) column and select 2 hours as the duration you want the device to be prioritized for.

Type	Information	Real-time Rate	Traffic Usage	Priority	Timing
	W7584 <small>(LAN) FC-AA-14-0D-23-18</small>	↑ 0 KB/s ↓ 0 KB/s	0KB	<input checked="" type="checkbox"/>	2 hours 1 h 59 min Remaining

3. Click [SAVE](#)

**Done!** You can now enjoy using your computer for the next 2 hours.

## Chapter 9

---

# Network Security

---

This chapter guides you on how to protect your home network from cyber attacks and unauthorized users by implementing these three network security functions. You can protect your home network from cyber attacks, block or allow specific client devices to access your network using Access Control, or you can prevent ARP spoofing and ARP attacks using IP & MAC Binding.

It contains the following sections:

- [Protect the Network from Cyber Attacks](#)
- [Access Control](#)
- [IP & MAC Binding](#)
- [ALG \(Application Layer Gateway\)](#)

## 9.1. Protect the Network from Cyber Attacks

The SPI (Stateful Packet Inspection) Firewall protects the router from cyber attacks and validate the traffic that is passing through the router based on the protocol. This function is enabled by default.

1. Visit <http://tplinkwifi.net>, and log in with your TP-Link ID or the password you set for the router.
2. Go to **Advanced > Security > Firewall**. It's recommended to keep the default settings.

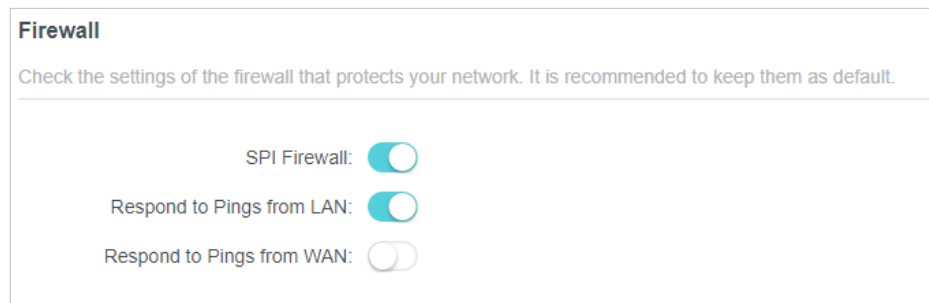

## 9.2. Access Control

Access Control is used to block or allow specific client devices to access your network (via wired or wireless) based on a list of blocked devices (Blacklist) or a list of allowed devices (Whitelist).

### I want to:

Block or allow specific client devices to access my network (via wired or wireless).

### How can I do that?

1. Visit <http://tplinkwifi.net>, and log in with your TP-Link ID or the password you set for the router.
2. Go to **Advanced > Security > Access Control**.
3. Toggle on to enable **Access Control**.
4. Select the access mode to either block (recommended) or allow the device(s) in the list.

#### To block specific device(s):

- 1) Select **Blacklist**.

**Access Control**



Control the access to your network from the specified devices.

Access Control:

Access Mode:  Blacklist  
 Configure a blacklist to only block access to your network from the specified devices.

Whitelist

- 2) Click  **Add** and select devices you want to be blocked and Click **ADD**.
- 3) The **Operation Succeeded** message will appear on the screen, which means the selected devices have been successfully added to the blacklist.

Device Type	Device Name	MAC Address	Modify
	Yan	38-CA-DA-3A-D8-B1	

**To allow specific device(s):**

- 1) Select **Whitelist** and click **SAVE**.

**Access Control**

Control the access to your network from the specified devices.

Access Control:

Access Mode:  Blacklist  
 Whitelist  
 Configure a whitelist to only allow access to your network from the specified devices.

- 2) Your own device is in the whitelist by default and cannot be deleted. Click  **Add** to add other devices to the whitelist.

Device Type	Device Name	MAC Address	Modify
	UNKNOWN	00-19-66-35-E1-B0	

- **Add connected devices**

- 1) Click **Select From Device List**.
- 2) Select the devices you want to be allowed and click **ADD**.



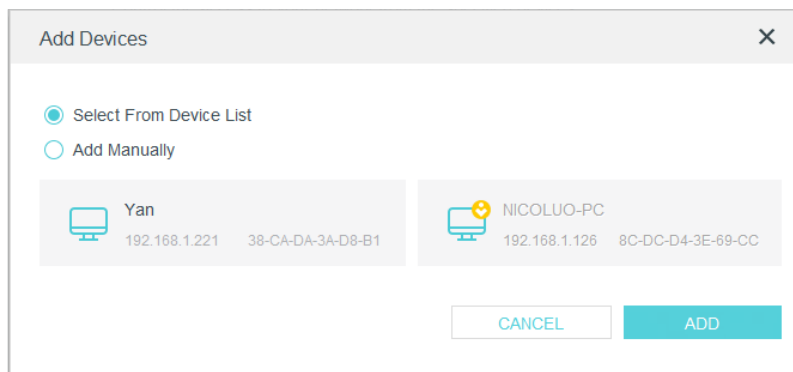

3) The **Operation Succeeded** message will appear on the screen, which means the selected devices have been successfully added to the whitelist.

- **Add unconnected devices**

1) Click **Add Manually**.

2) Enter the **Device Name** and **MAC Address** of the device you want to be allowed and click **ADD**.

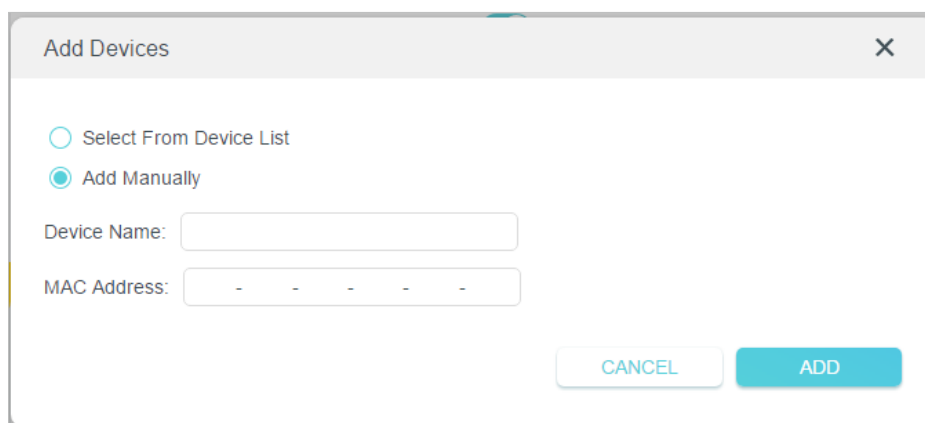

3) The **Operation Succeeded** message will appear on the screen, which means the device has been successfully added to the whitelist.

## Done!

Now you can block or allow specific client devices to access your network (via wired or wireless) using the **Blacklist** or **Whitelist**.

## 9.3. IP & MAC Binding

IP & MAC Binding, namely, ARP (Address Resolution Protocol) Binding, is used to bind network device's IP address to its MAC address. This will prevent ARP Spoofing and other ARP attacks by denying network access to an device with matching IP address in the Binding list, but unrecognized MAC address.

## I want to:

Prevent ARP spoofing and ARP attacks.

## How can I do that?

1. Visit <http://tplinkwifi.net>, and log in with your TP-Link ID or the password you set for the router.
2. Go to [Advanced](#) > [Security](#) > [IP & MAC Binding](#).
3. Enable [IP & MAC Binding](#).

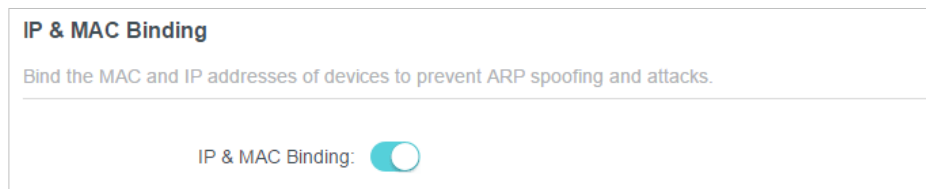

**IP & MAC Binding**

Bind the MAC and IP addresses of devices to prevent ARP spoofing and attacks.

IP & MAC Binding:

4. Bind your device(s) according to your need.

### To bind the connected device(s):

- 1) Click [+](#) Add in the [Binding List](#) section.

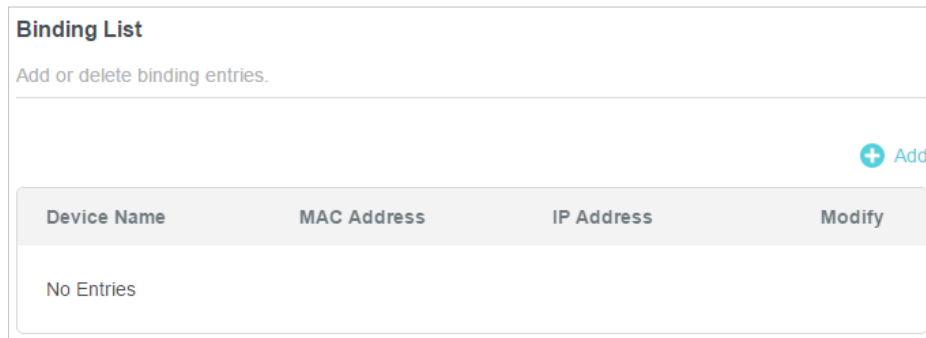

**Binding List**

Add or delete binding entries.

[+](#) Add

Device Name	MAC Address	IP Address	Modify
No Entries			

- 2) Click [VIEW CONNECTED DEVICES](#) and select the device you want to bind. The [MAC Address](#) and [IP Address](#) fields will be automatically filled in.

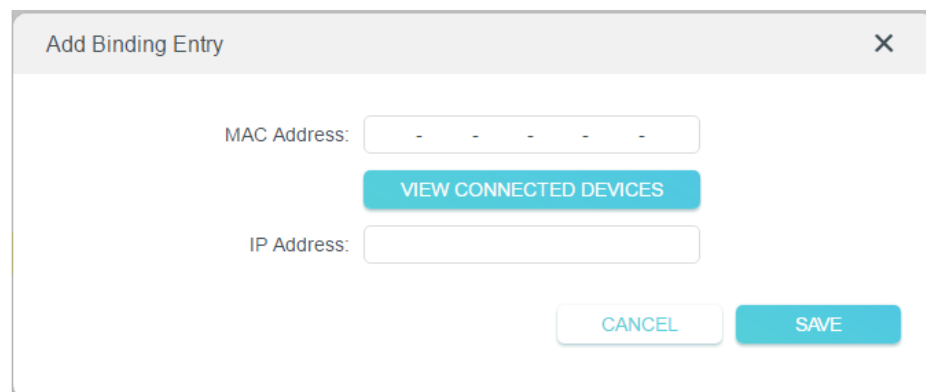

**Add Binding Entry** ×

MAC Address:

[VIEW CONNECTED DEVICES](#)

IP Address:

[CANCEL](#) [SAVE](#)

- 3) Click [SAVE](#).

**To bind the unconnected device:**

- 1) Click  Add in the [Binding List](#) section.

**Binding List**  
Add or delete binding entries.

 Add

Device Name	MAC Address	IP Address	Modify
No Entries			

- 2) Enter the [MAC Address](#) and [IP Address](#) that you want to bind.

**Done!**

Now you don't need to worry about ARP spoofing and ARP attacks!

## 9. 4. ALG (Application Layer Gateway)

View your ALG (Application Layer Gateway) settings in this page. It is recommended to keep them as default.

**ALG**  
Check the ALG (Application Layer Gateway) settings. It is recommended to keep them as default.

PPTP Passthrough:

L2TP Passthrough:

IPSec Passthrough:

FTP ALG:

TFTP ALG:

RTSP ALG:

H323 ALG:

SIP ALG:

## Chapter 10

---

# NAT Forwarding

---

The router's NAT (Network Address Translation) feature makes devices on the LAN use the same public IP address to communicate with devices on the internet, which protects the local network by hiding IP addresses of the devices. However, it also brings about the problem that an external host cannot initiatively communicate with a specified device on the local network.

With the forwarding feature the router can penetrate the isolation of NAT and allows devices on the internet to initiatively communicate with devices on the local network, thus realizing some special functions.

The TP-Link router supports four forwarding rules. If two or more rules are set, the priority of implementation from high to low is Port Forwarding, Port Triggering, UPnP and DMZ.

It contains the following sections:

- [Share Local Resources on the Internet by Port Forwarding](#)
- [Open Ports Dynamically by Port Triggering](#)
- [Make Xbox Online Games Run Smoothly by UPnP](#)
- [Make Applications Free from Port Restriction by DMZ](#)

## 10.1. Share Local Resources on the Internet by Port Forwarding

When you build up a server on the local network and want to share it on the internet, Port Forwarding can realize the service and provide it to internet users. At the same time Port Forwarding can keep the local network safe as other services are still invisible from the internet.

Port Forwarding can be used for setting up public services on your local network, such as HTTP, FTP, DNS, POP3/SMTP and Telnet. Different services use different service ports. Port 80 is used in HTTP service, port 21 in FTP service, port 25 in SMTP service and port 110 in POP3 service. Please verify the service port number before the configuration.

### I want to:

Share my personal website I've built in local network with my friends through the internet.

*For example*, the personal website has been built on my home PC (192.168.0.100). I hope that my friends on the internet can visit my website in some way. The PC is connected to the router with the WAN IP address 218.18.232.154.

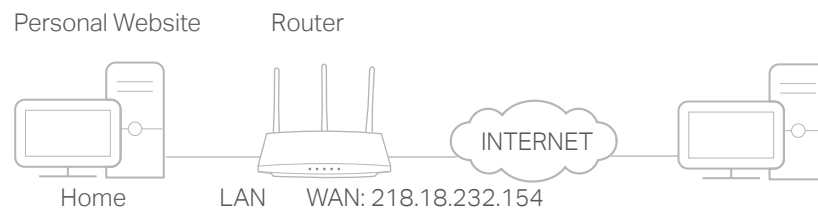

### How can I do that?

1. Assign a static IP address to your PC, for example 192.168.0.100.
2. Visit <http://tplinkwifi.net>, and log in with your TP-Link ID or the password you set for the router.
3. Go to **Advanced > NAT Forwarding > Port Forwarding**.
4. Click  **Add**.

**Port Forwarding**

Specify ports to make specific devices or services on your local network accessible over the internet.

[+ Add](#)

Service Name	Device IP Address	External Port	Internal Port	Protocol	Status	Modify
No Entries in this table.						

5. Click [VIEW COMMON SERVICES](#) and select [HTTP](#). The [External Port](#), [Internal Port](#) and [Protocol](#) will be automatically filled in.
6. Click [VIEW CONNECTED DEVICES](#) and select your home PC. The [Device IP Address](#) will be automatically filled in. Or enter the PC's IP address manually in the [Device IP Address](#) field.
7. Click [SAVE](#).

**Add a Port Forwarding Entry** ✕

Service Name:

[VIEW COMMON SERVICES](#)

Device IP Address:

[VIEW CONNECTED DEVICES](#)

External Port:

Internal Port:

Protocol:  ▼

Enable This Entry

[CANCEL](#) [SAVE](#)

**Tips:**

- It is recommended to keep the default settings of [Internal Port](#) and [Protocol](#) if you are not clear about which port and protocol to use.
- If the service you want to use is not in the common services list, you can enter the corresponding parameters manually. You should verify the port number that the service needs.
- You can add multiple port forwarding rules if you want to provide several services in a router. Please note that the [External Port](#) should not be overlapped.

## Done!

Users on the internet can enter [http:// WAN IP](#) (in this example: [http:// 218.18.232.154](#)) to visit your personal website.

📌 **Tips:**

- The WAN IP should be a public IP address. For the WAN IP is assigned dynamically by the ISP, it is recommended to apply and register a domain name for the WAN referring to [Make Applications Free from Port Restriction by DMZ](#). Then users on the internet can use [http:// domain name](#) to visit the website.
- If you have changed the default **External Port**, you should use [http:// WAN IP: External Port](#) or [http:// domain name: External Port](#) to visit the website.

## 10.2. Open Ports Dynamically by Port Triggering

Port Triggering can specify a triggering port and its corresponding external ports. When a host on the local network initiates a connection to the triggering port, all the external ports will be opened for subsequent connections. The router can record the IP address of the host. When the data from the internet return to the external ports, the router can forward them to the corresponding host. Port Triggering is mainly applied to online games, VoIPs, video players and common applications including MSN Gaming Zone, Dialpad and Quick Time 4 players, etc.

Follow the steps below to configure the Port Triggering rules:

1. Visit <http://tplinkwifi.net>, and log in with your TP-Link ID or the password you set for the router.
2. Go to **Advanced > NAT Forwarding > Port Triggering** and click **+ Add**.

**Port Triggering**

Specify ports to allow devices on your local network to dynamically open specific external ports and forward packets (from the internet) to the device that triggered it.

+ Add

Service Name	Triggering Port	Triggering Protocol	External Port	External Protocol	Status	Modify
No Entries						

3. Click **VIEW COMMON SERVICES**, and select the desired application. The **Triggering Port**, **Triggering Protocol** and **External Port** will be automatically filled in. The following picture takes application **MSN Gaming Zone** as an example.

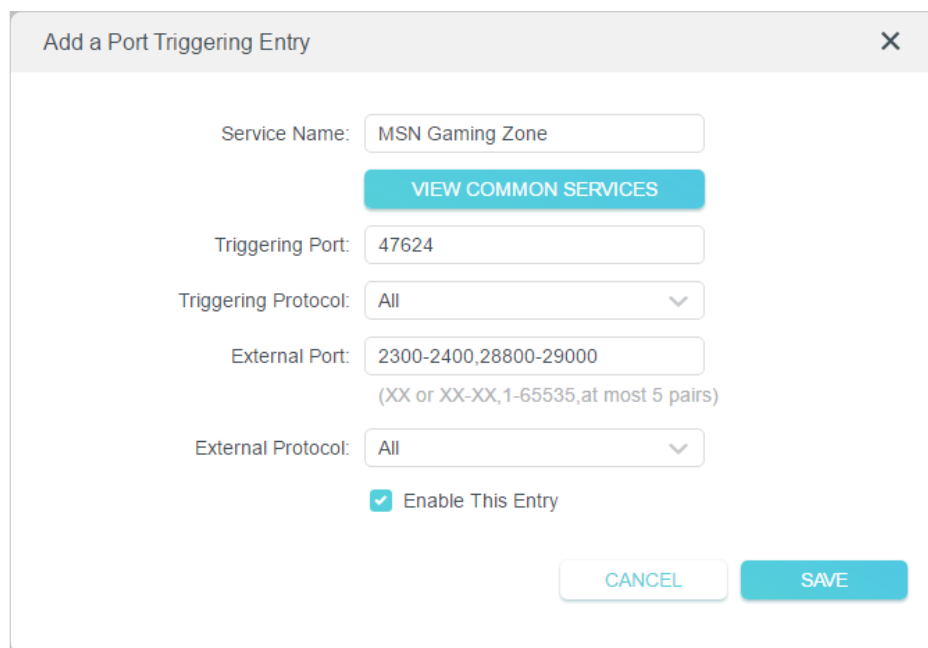

Add a Port Triggering Entry

Service Name: MSN Gaming Zone

VIEW COMMON SERVICES

Triggering Port: 47624

Triggering Protocol: All

External Port: 2300-2400,28800-29000  
(XX or XX-XX,1-65535,at most 5 pairs)

External Protocol: All

Enable This Entry

CANCEL SAVE

#### 4. Click **SAVE**.

##### Tips:

- You can add multiple port triggering rules according to your network need.
- The triggering ports can not be overlapped.
- If the application you need is not listed in the Existing Applications list, please enter the parameters manually. You should verify the external ports the application uses first and enter them into [External Port](#) field according to the format the page displays.

## 10.3. Make Xbox Online Games Run Smoothly by UPnP

The UPnP (Universal Plug and Play) protocol allows applications or host devices to automatically find the front-end NAT device and send request to it to open the corresponding ports. With UPnP enabled, the applications or host devices on the local network and the internet can freely communicate with each other thus realizing the seamless connection of the network. You may need to enable the UPnP if you want to use applications for multiplayer gaming, peer-to-peer connections, real-time communication (such as VoIP or telephone conference) or remote assistance, etc.

##### Tips:

- UPnP is enabled by default in this router.
- Only the application supporting UPnP protocol can use this feature.
- UPnP feature needs the support of operating system (e.g. Windows Vista/ Windows 7/ Windows 8, etc. Some of operating system need to install the UPnP components).

[For example](#), when you connect your Xbox to the router which has connected to the internet to play online games, UPnP will send request to the router to open the corresponding ports allowing the following data penetrating the NAT to transmit. Therefore, you can play Xbox online games without a hitch.



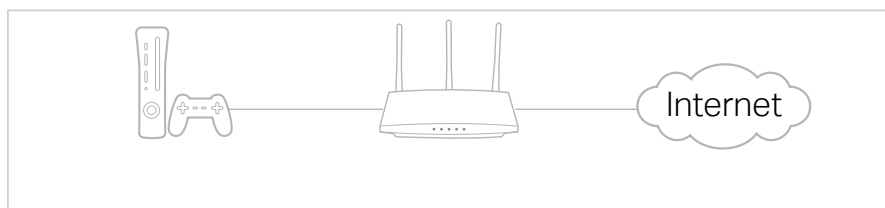

If necessary, you can follow the steps to change the status of UPnP.

1. Visit <http://tplinkwifi.net>, and log in with your TP-Link ID or the password you set for the router.
2. Go to **Advanced > NAT Forwarding > UPnP** and toggle on or off according to your needs.

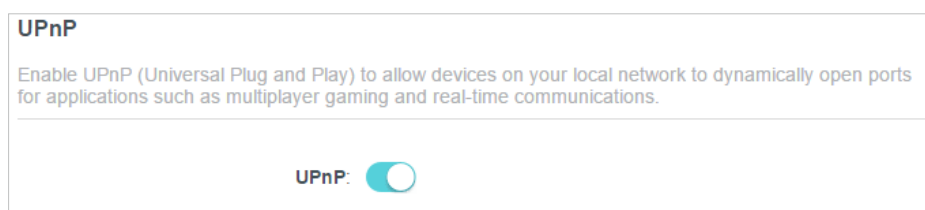

## 10.4. Make Applications Free from Port Restriction by DMZ

When a PC is set to be a DMZ (Demilitarized Zone) host on the local network, it is totally exposed to the internet, which can realize the unlimited bidirectional communication between internal hosts and external hosts. The DMZ host becomes a virtual server with all ports opened. When you are not clear about which ports to open in some special applications, such as IP camera and database software, you can set the PC to be a DMZ host.

### Note:

When DMZ is enabled, the DMZ host is totally exposed to the internet, which may bring some potential safety hazards. If DMZ is not in use, please disable it in time.

### I want to:

Make the home PC join the internet online game without port restriction.

**For example**, due to some port restriction, when playing the online games, you can log in normally but cannot join a team with other players. To solve this problem, set your PC as a DMZ host with all ports open.

### How can I do that?

1. Assign a static IP address to your PC, for example 192.168.0.100.
2. Visit <http://tplinkwifi.net>, and log in with your TP-Link ID or the password you set for the router.

3. Go to [Advanced](#) > [NAT Forwarding](#) > [DMZ](#) and tick to enable DMZ.
4. Click [VIEW CONNECTED DEVICES](#) and select your PC. The [Device IP Address](#) will be automatically filled in. Or enter the PC's IP address 192.168.0.100 manually in the [DMZ Host IP Address](#) field.

**DMZ**

Expose a specific device in your local network to the internet for applications such as online gaming and real-time communications.

---

DMZ:  Enable

DMZ Host IP Address:

[VIEW CONNECTED DEVICES](#)

5. Click [SAVE](#).

## Done!

The configuration is completed. You've set your PC to a DMZ host and now you can make a team to game with other players.

## Chapter 11

---

# Customize Your Network Settings

---

This chapter guides you on how to configure advanced network features.

It contains the following sections:

- [Change the LAN Settings](#)
- [Configure to Support IPTV Service](#)
- [Specify DHCP Server Settings](#)
- [Set Up a Dynamic DNS Service Account](#)
- [Create Static Routes](#)
- [Specify Wireless Settings](#)
- [Schedule Your Wireless Function](#)
- [Use WPS for Wireless Connection](#)
- [Advanced Wireless Settings](#)

## 11.1. Change the LAN Settings

The router is preset with a default LAN IP 192.168.0.1, which you can use to log in to its web management page. The LAN IP address together with the Subnet Mask also defines the subnet that the connected devices are on. If the IP address conflicts with another device on your local network or your network requires a specific IP subnet, you can change it.

1. Visit <http://tplinkwifi.net>, and log in with your TP-Link ID or the password you set for the router.
2. Go to [Advanced](#) > [Network](#) > [LAN](#).
3. Type in a new IP Address appropriate to your needs. And leave the [Subnet Mask](#) as the default settings.



LAN

View and configure LAN settings.

MAC Address: 98-DA-C4-B4-01-D8

IP Address:

Subnet Mask:  ▼

4. Click [SAVE](#).

**Note:** If you have set the Port Forwarding, DMZ or DHCP address reservation, and the new LAN IP address is not in the same subnet with the old one, then you should reconfigure these features.

## 11.2. Configure to Support IPTV Service

### I want to:

Configure IPTV setup to enable Internet/IPTV/Phone service provided by my internet service provider (ISP).

### How can I do that?

1. Visit <http://tplinkwifi.net>, and log in with your TP-Link ID or the password you set for the router.
2. Go to [Advanced](#) > [Network](#) > [IPTV/VLAN](#).
3. Configure IPTV/VLAN settings:
  - 1) Tick [Enable IPTV/VLAN](#).
  - 2) Select the appropriate [Mode](#) according to your ISP.
    - Select [Bridge](#) if your ISP is not listed and no other parameters are required.

- Select **Custom** if your ISP is not listed but provides necessary parameters.

**IPTV/VLAN**

Configure IPTV/VLAN settings if you want to enjoy IPTV or VoIP service, or if your ISP requires VLAN tags.

---

IPTV/VLAN:  Enable

Mode: Bridge ▼

LAN1: Portugal-Meo

LAN2: Portugal-Vodafone

LAN3: Australia-NBN

LAN4: New Zealand-UFB

LAN4: Bridge

          Custom

- 3) After you have selected a mode, the necessary parameters, including the LAN port for IPTV connection, are predetermined. If not, select the LAN type to determine which port is used to support IPTV service.
- 4) Click **SAVE**.
- 5) Connect the set-top box to the corresponding LAN port which is predetermined or you have specified in Step 3.

## Done!

Your IPTV setup is done now! You may need to configure your set-top box before enjoying your TV.

## 11.3. Specify DHCP Server Settings

By default, the DHCP (Dynamic Host Configuration Protocol) Server is enabled and the router acts as a DHCP server; it dynamically assigns TCP/IP parameters to client devices from the IP Address Pool. You can change the settings of the DHCP Server if necessary, and you can reserve LAN IP addresses for specified client devices.

1. Visit <http://tplinkwifi.net>, and log in with your TP-Link ID or the password you set for the router.
2. Go to **Advanced > Network > DHCP Server**.

- **To specify the IP address that the router assigns:**

**DHCP Server**

Dynamically assign IP addresses to the devices connected to the router.

**DHCP Server:**  Enable

IP Address Pool:  -

Address Lease Time:  minutes

Default Gateway:  (Optional)

Primary DNS:  (Optional)

Secondary DNS:  (Optional)

1. Tick the **Enable** checkbox.
  2. Enter the starting and ending IP addresses in the **IP Address Pool**.
  3. Enter other parameters if the ISP offers. The **Default Gateway** is automatically filled in and is the same as the LAN IP address of the router.
  4. Click **SAVE**.
- **To reserve an IP address for a specified client device:**
    1. Click **Add** in the **Address Reservation** section.

**Add a Reservation Entry** X

MAC Address:

IP Address:

2. Click **VIEW CONNECTED DEVICES** and select the you device you want to reserve an IP for. Then the **MAC Address** will be automatically filled in. Or enter the **MAC address** of the client device manually.
3. Enter the **IP address** to reserve for the client device.
4. Click **SAVE**.

## 11.4. Set Up a Dynamic DNS Service Account

Most ISPs assign a dynamic IP address to the router and you can use this IP address to access your router remotely. However, the IP address can change from time to time and you don't know when it changes. In this case, you might apply the DDNS (Dynamic

Domain Name Server) feature on the router to allow you and your friends to access your router and local servers (FTP, HTTP, etc.) using a domain name without checking and remembering the IP address.

**Note:** DDNS does not work if the ISP assigns a private WAN IP address (such as 192.168.1.x) to the router.

1. Visit <http://tplinkwifi.net>, and log in with your TP-Link ID or the password you set for the router.
2. Go to **Advanced > Network > Dynamic DNS**.
3. Select the DDNS **Service Provider**: TP-Link, NO-IP or DynDNS. It is recommended to select TP-Link so that you can enjoy TP-Link's superior DDNS service. Otherwise, please select NO-IP or DynDNS. If you don't have a DDNS account, you have to register first by clicking **Register Now**.

**Dynamic DNS**

Assign a fixed host name (domain name) for remote access to your device, website, or server behind the router.

---

Service Provider:

**Note:** To enjoy TP-Link's DDNS service, you have to log in with a TP-Link ID. If you have not logged in with one, click **log in**.

4. Click **Register** in the **Domain Name List** if you have selected TP-Link, and enter the **Domain Name** as needed.

**Dynamic DNS**

Assign a fixed host name (domain name) for remote access to your device, website, or server behind the router.

---

Service Provider:

Current Domain Name:

**Domain Name List**

[+ Register](#)

Domain Name	Registered Date	Status	Operation	Delete
No Entries				

If you have selected NO-IP or DynDNS, enter the username, password and domain name of your account.

### Dynamic DNS

Assign a fixed host name (domain name) for remote access to your device, website, or server behind the router.

---

Service Provider:  [Register Now](#)

Username:

Password:  🔑 🔍

Domain Name:

WAN IP binding:  Enable

Status: Not launching

[LOGIN AND SAVE](#)

[LOGOUT](#)

5. Click [LOGIN AND SAVE](#).

🔗 **Tips:** If you want to use a new DDNS account, please click [Logout](#) first, and then log in with a new account.

## 11.5. Create Static Routes

Static routing is a form of routing that is configured manually by a network administrator or a user by adding entries into a routing table. The manually-configured routing information guides the router in forwarding data packets to the specific destination.

### I want to:

Visit multiple networks and servers at the same time.

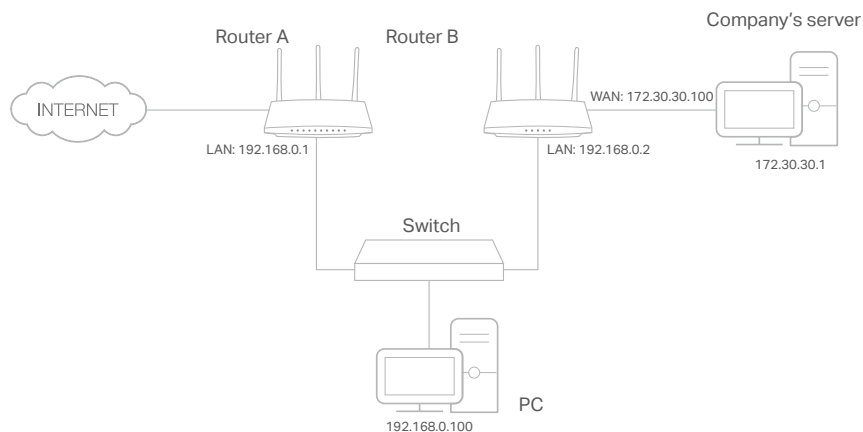

**For example,** in a small office, my PC can surf the internet through Router A, but I also want to visit my company's network. Now I have a switch and Router B. I connect the devices as shown in the following figure so that the physical connection between my PC and my company's server is established. To surf the internet and visit my company's



network at the same time, I need to configure the static routing.

## How can I do that?

1. Change the routers' LAN IP addresses to two different IP addresses on the same subnet. Disable Router B's DHCP function.
2. Visit <http://tplinkwifi.net>, and log in with your TP-Link ID or the password you set for Router A.
3. Go to [Advanced](#) > [Network](#) > [Routing](#).
4. Click [Add](#) and finish the settings according to the following explanations:

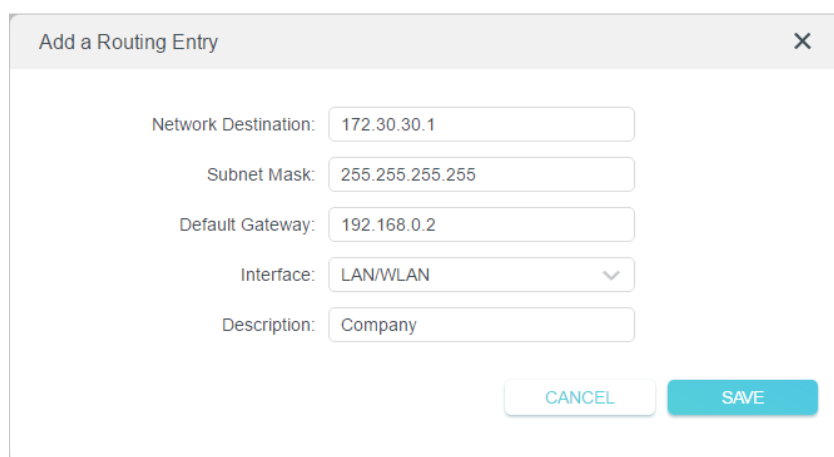

The screenshot shows a dialog box titled "Add a Routing Entry" with a close button (X) in the top right corner. The dialog contains the following fields and values:

- Network Destination: 172.30.30.1
- Subnet Mask: 255.255.255.255
- Default Gateway: 192.168.0.2
- Interface: LAN/WLAN (dropdown menu)
- Description: Company

At the bottom right of the dialog, there are two buttons: "CANCEL" and "SAVE".

- **Network Destination:** The destination IP address that you want to assign to a static route. This IP address cannot be on the same subnet with the WAN IP or LAN IP of Router A. In the example, the IP address of the company network is the destination IP address, so here enter 172.30.30.1.
  - **Subnet Mask:** Determines the destination network with the destination IP address. If the destination is a single IP address, enter 255.255.255.255; otherwise, enter the subnet mask of the corresponding network IP. In the example, the destination network is a single IP, so here enter 255.255.255.255.
  - **Default Gateway:** The IP address of the gateway device to which the data packets will be sent. This IP address must be on the same subnet with the router's IP which sends out data. In the example, the data packets will be sent to the LAN port of Router B and then to the Server, so the default gateway should be 192.168.0.2.
  - **Interface:** Determined by the port (WAN/LAN) that sends out data packets. In the example, the data are sent to the gateway through the LAN port of Router A, so [LAN/WLAN](#) should be selected.
  - **Description:** Enter a description for this static routing entry.
5. Click [SAVE](#).

6. Check the [Routing Table](#) below. If you can find the entry you've set, the static routing is set successfully.

**Routing Table**

View all valid routing entries that are currently in use.

---

Active Route Number: 1  Refresh

Network Destination	Subnet Mask	Gateway	Interface
192.168.0.0	255.255.255.0	0.0.0.0	LAN

## Done!

Open a web browser on your PC. Enter the company server's IP address to visit the company network.

## 11.6. Specify Wireless Settings

The router's wireless network name (SSID) and password, and security option are preset in the factory. The preset SSID and password can be found on the label of the router. You can customize the wireless settings according to your needs.

Visit <http://tplinkwifi.net>, and log in with your TP-Link ID or the password you set for the router.

- **To enable or disable the wireless function:**

1. Go to [Wireless](#) or [Advanced](#) > [Wireless](#) > [Wireless Settings](#).
2. The wireless function is enabled by default. If you want to disable the wireless function of the router, just untick the [Enable](#) checkbox of each wireless network. In this case, all the wireless settings will be invalid.

- **To change the wireless network name (SSID) and wireless password:**

1. Go to [Wireless](#) or [Advanced](#) > [Wireless](#) > [Wireless Settings](#).
2. Create a new SSID in [Network Name \(SSID\)](#) and customize the password for the network in [Password](#). The value is case-sensitive.

**Note:** If you change the wireless settings with a wireless device, you will be disconnected when the settings are effective. Please write down the new SSID and password for future use.

- **To hide SSID:**

1. Go to [Wireless](#) or [Advanced](#) > [Wireless](#) > [Wireless Settings](#).
2. Select [Hide SSID](#), and your SSID won't display when you scan for local wireless networks on your wireless device and you need to manually join the network.

- **To use the Smart Connect function:**

The Smart Connect function lets you to enjoy a more high-speed network by assigning your devices to best wireless bands based on actual conditions to balance network demands.

1. Go to [Advanced](#) > [Wireless](#) > [Wireless Settings](#).
2. Enable [Smart Connect](#).

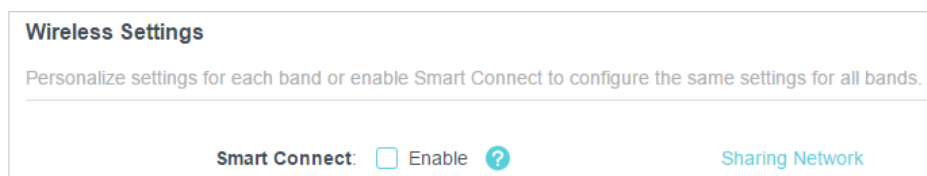

3. Keep the default values or set a new SSID and password, and click [SAVE](#). This SSID and password will be applied for the 2.4GHz and 5GHz wireless networks.

- **To change the security option:**

1. Go to [Advanced](#) > [Wireless](#) > [Wireless Settings](#).
2. Select an option from the [Security](#) drop-down list. We recommend you don't change the default settings unless necessary.

#### In addition

- [Transmit Power](#) - Select either [High](#), [Middle](#) or [Low](#) to specify the data transmit power. The default and recommended setting is [High](#).
- [Channel Width](#) - Select a channel width (bandwidth) for the wireless network.
- [Channel](#) - Select an operating channel for the wireless network. It is recommended to leave the channel to [Auto](#), if you are not experiencing the intermittent wireless connection issue.
- [Mode](#) - Select a transmission mode according to your wireless client devices. It is recommended to just leave it as default.

- **To enable the MU-MIMO feature:**

A router with the MU-MIMO feature serves multiple devices simultaneously while a traditional router serves only one user at a time. That means MU-MIMO can provide a faster, more efficient Wi-Fi network for multiuser.

**Note:**

Devices supporting 5GHz wireless band can enjoy the MU-MIMO service.

1. Go to [Advanced](#) > [Wireless](#) > [Wireless Settings](#).
2. Locate the [5GHz](#) network.
3. Tick the [Enable](#) box for [MU-MIMO](#).
4. Click [SAVE](#).

## 11.7. Schedule Your Wireless Function

The wireless network can be automatically off at a specific time when you do not need the wireless connection.

1. Visit <http://tplinkwifi.net>, and log in with your TP-Link ID or the password you set for the router.
2. Go to [Advanced](#) > [Wireless](#) > [Wireless Schedule](#).
3. Enable the [Wireless Schedule](#) feature.

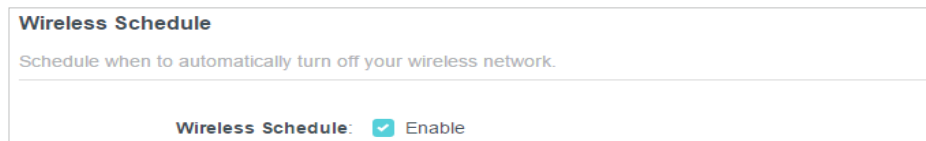

4. Click [Add](#) to specify a wireless off period during which you need the wireless off automatically, and click [SAVE](#).

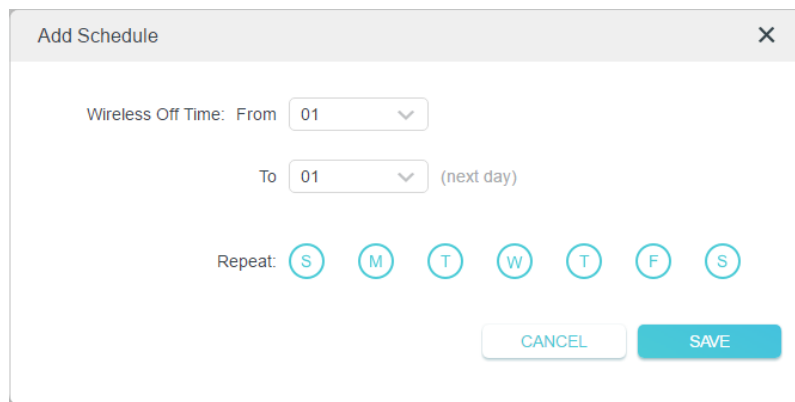

**Note:**

- The Effective Time Schedule is based on the time of the router. You can go to [Advanced](#) > [System](#) > [Time & Language](#) to modify the time.
- The wireless network will be automatically turned on after the time period you set.

## 11.8. Use WPS for Wireless Connection

Wi-Fi Protected Setup (WPS) provides an easier approach to set up a security-protected Wi-Fi connection.

1. Visit <http://tplinkwifi.net>, and log in with your TP-Link ID or the password you set for the router.
2. Make sure the Wi-Fi of your router is on and go to [Advanced](#) > [Wireless](#) > [WPS](#).

### 11.8.1. Connect via the Client's PIN

Enter the PIN of your device and click **Connect**. Then your device will get connected to the router.

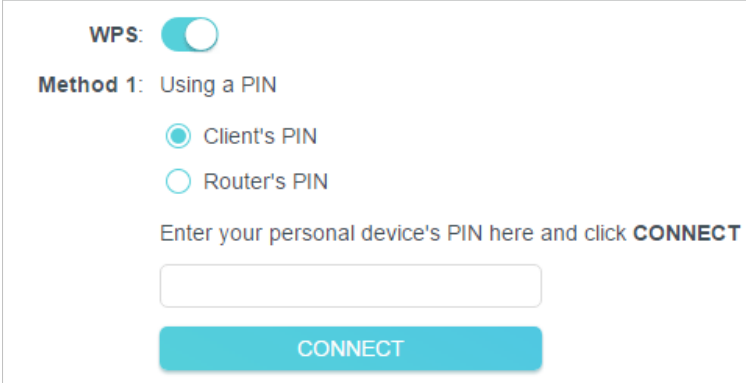

**WPS:**

**Method 1:** Using a PIN

Client's PIN

Router's PIN

Enter your personal device's PIN here and click **CONNECT**

**CONNECT**

### 11.8.2. Connect via the Router's PIN

Select **Router's PIN** in **Method 1** to enable **Router's PIN**. You can use the default PIN or generate a new one.

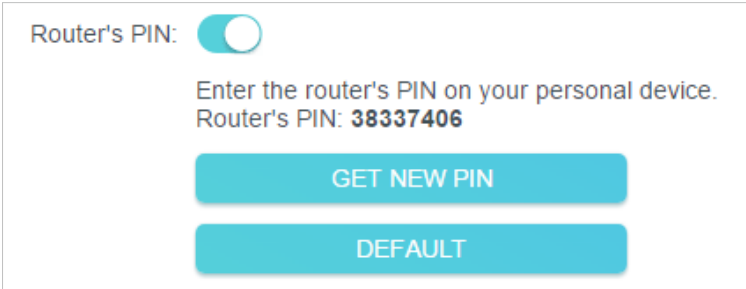

**Router's PIN:**

Enter the router's PIN on your personal device.  
Router's PIN: **38337406**

**GET NEW PIN**

**DEFAULT**

**Note:**

PIN (Personal Identification Number) is an eight-character identification number preset to each router. WPS supported devices can connect to your router with the PIN. The default PIN is printed on the label of the router.

### 11.8.3. Push the WPS Button

Click **Start** on the screen or directly press the router's WPS button. Within two minutes, enable WPS on your personal device. **Success** will appear on the screen and the WPS LED of the router should change from flashing to solid on, indicating successful WPS connection.

**Method 2:** Using the button below

Click the button below, then enable WPS on your personal device within 2 minutes.

**Method 3:** Using the router's WPS button

Press the router's WPS button, then enable WPS on your personal device within 2 minutes.

## 11.9. Advanced Wireless Settings

Check advanced wireless settings for your device.

1. Visit <http://tplinkwifi.net>, and log in with your TP-Link ID or the password you set for the router.
2. Go to [Advanced > Wireless > Additional Settings](#).
3. Configure advanced wireless settings.

### Additional Settings

Check advanced wireless settings for your device.

---

WMM:  Enable

Short GI:  Enable

AP Isolation:  Enable

Airtime Fairness:  Enable

Beacon Interval:

RTS Threshold:

DTIM Interval:

Group Key Update Period:  s

- **WMM** - WMM function can guarantee the packets with high-priority messages being transmitted preferentially.

- **Short GI** - It is recommended to enable this function, for it will increase the data capacity by reducing the guard interval time.
- **AP Isolation** - This function isolates all connected wireless stations so that wireless stations cannot access each other through WLAN.
- **Airtime Fairness** - This function can improve the overall network performance by sacrificing a little bit of network time on your slow devices.
- **Beacon Interval** - Enter a value between 40 and 1000 in milliseconds to determine the duration between beacon packets that are broadcasted by the router to synchronize the wireless network. The default value is 100 milliseconds.
- **RTS Threshold**- Enter a value between 1 and 2346 to determine the packet size of data transmission through the router. By default, the RTS (Request to Send) Threshold size is 2346. If the packet size is greater than the preset threshold, the router will send RTS frames to a particular receiving station and negotiate the sending of a data frame.
- **DTIM Interval** - The value determines the interval of DTIM (Delivery Traffic Indication Message). Enter a value between 1 and 15 intervals. The default value is 1, which indicates the DTIM Interval is the same as Beacon Interval.
- **Group Key Update Period** - Enter a number of seconds (minimum 30) to control the time interval for the encryption key automatic renewal. The default value is 0, meaning no key renewal.

## Chapter 12

---

# Manage the Router

---

This chapter will show you the configuration for managing and maintaining your router.

It contains the following sections:

- [Upgrade the Firmware](#)
- [Backup and Restore Configuration Settings](#)
- [Change the Login Password](#)
- [Local Management](#)
- [Remote Management](#)
- [View System Log](#)
- [Test the Network Connectivity](#)
- [Set Up System Time](#)
- [Set the Router to Reboot Regularly](#)
- [Control the LED](#)



## 12. 1. Upgrade the Firmware

TP-Link aims at providing better network experience for users.

We will inform you through the web management page if there's any update firmware available for your router. Also, the latest firmware will be released at the TP-Link official website [www.tp-link.com](http://www.tp-link.com), and you can download it from the [Support](#) page for free.

### Notes:

- Backup your router configuration before firmware upgrade.
- Do NOT turn off the router during the firmware upgrade.

### 12. 1. 1. Online Upgrade

1. Visit <http://tplinkwifi.net>, and log in with your TP-Link ID or the password you set for the router.
2. When the latest firmware is available for your router, the upgrade icon  will display in the top-right corner of the page. Click the icon to go to the [Firmware Upgrade](#) page.

Alternatively, you can go to [Advanced](#) > [System](#) > [Firmware Upgrade](#), and click [CHECK FOR UPGRADES](#) to see whether the latest firmware is released. If there is new firmware click [UPGRADE](#).

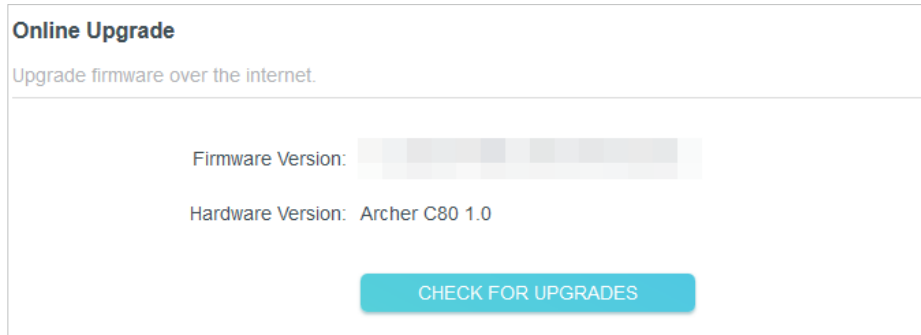

3. Wait a few minutes for the upgrade and reboot to complete.

 **Tips:** If there's a new and important firmware update for your router, you will see the prompt notification on your computer as long as a web browser is opened. Click [UPGRADE](#), and log in to the web management page with the username and password you set for the router. You will see the [Firmware Upgrade](#) page.

### 12. 1. 2. Local Upgrade

1. Download the latest firmware file for the router from [www.tp-link.com](http://www.tp-link.com).
2. Visit <http://tplinkwifi.net>, and log in with your TP-Link ID or the password you set for the router.
3. Go to [Advanced](#) > [System](#) > [Firmware Upgrade](#).

4. Focus on the **Local Upgrade** section. Click **BROWSE** to locate the downloaded new firmware file, and click **UPGRADE**.

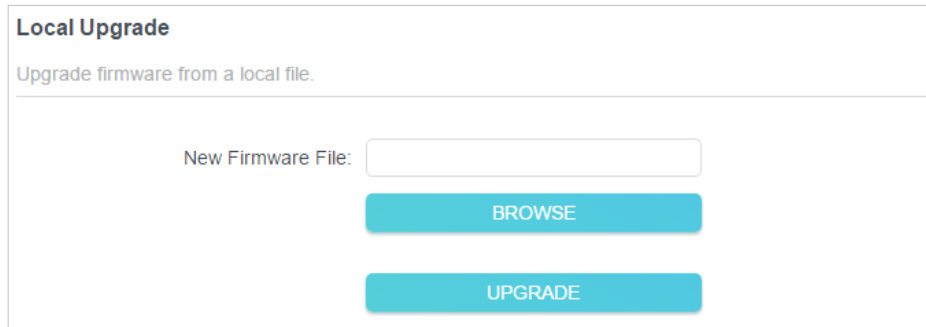

The screenshot shows a web interface titled "Local Upgrade" with the subtitle "Upgrade firmware from a local file." Below the subtitle is a text input field labeled "New Firmware File:". Underneath the input field are two blue buttons: "BROWSE" and "UPGRADE".

5. Wait a few minutes for the upgrade and reboot to complete.

**Note:** If you fail to upgrade the firmware for the router, please contact our [Technical Support](#).

## 12.2. Backup and Restore Configuration Settings

The configuration settings are stored as a configuration file in the router. You can backup the configuration file to your computer for future use and restore the router to a previous settings from the backup file when needed. Moreover, if necessary you can erase the current settings and reset the router to the default factory settings.

1. Visit <http://tplinkwifi.net>, and log in with your TP-Link ID or the password you set for the router.
2. Go to **Advanced > System Tools > Backup & Restore**.

- **To backup configuration settings:**

Click **BACK UP** to save a copy of the current settings to your local computer. A '.bin' file of the current settings will be stored to your computer.

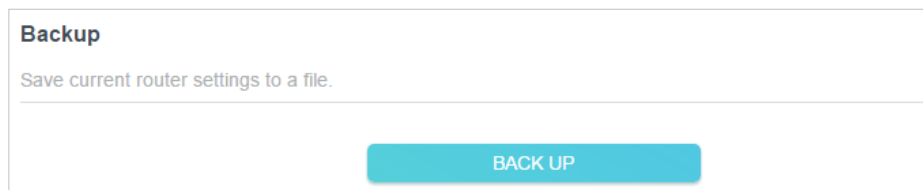

The screenshot shows a web interface titled "Backup" with the subtitle "Save current router settings to a file." Below the subtitle is a large blue button labeled "BACK UP".

- **To restore configuration settings:**

1. Click **BROWSE** to locate the backup configuration file stored on your computer, and click **RESTORE**.

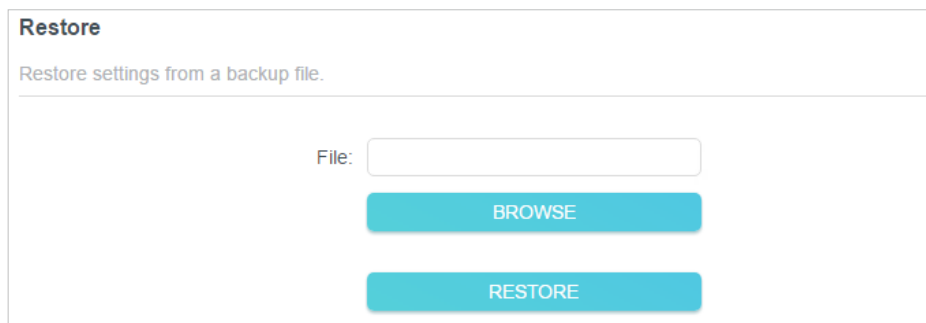

**Restore**

Restore settings from a backup file.

File:

**BROWSE**

**RESTORE**

2. Wait a few minutes for the restoring and rebooting.

**Note:** During the restoring process, do not turn off or reset the router.

- **To reset the router except your login password and TP-Link ID:**

1. In the [Factory Default Restore](#) section, click **RESTORE**.

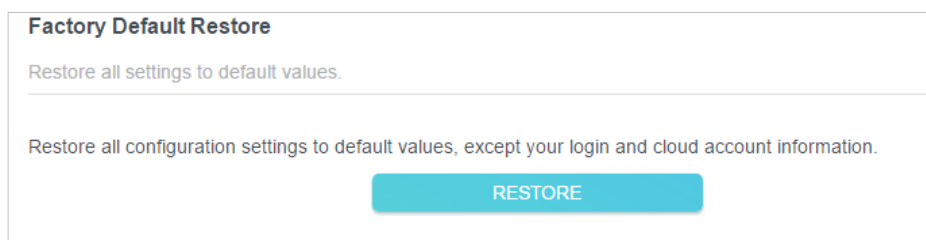

**Factory Default Restore**

Restore all settings to default values.

Restore all configuration settings to default values, except your login and cloud account information.

**RESTORE**

2. Wait a few minutes for the resetting and rebooting.

**Note:**

- During the resetting process, do not turn off the router.
- After reset, you can still use the current login password or the TP-Link ID to log in to the web management page.

- **To reset the router to factory default settings:**

1. Click **FACTORY RESTORE** to reset the router.

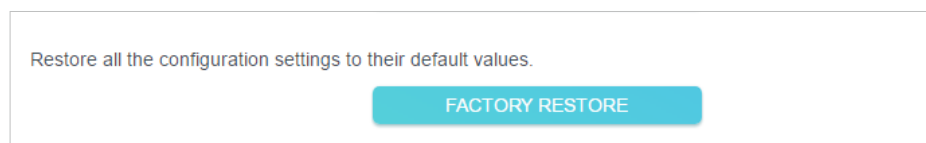

Restore all the configuration settings to their default values.

**FACTORY RESTORE**

2. Wait a few minutes for the resetting and rebooting.

**Note:**

- During the resetting process, do not turn off or reset the router.
- We strongly recommend you backup the current configuration settings before resetting the router.

## 12.3. Change the Login Password

The account management feature allows you to change your login password of the web management page.

**Note:** If you are using a TP-Link ID to log in to the web management page, the account management feature will be disabled. To manage the TP-Link ID, go to [Advanced > TP-Link ID](#).

1. Visit <http://tplinkwifi.net>, and log in with the password you set for the router.
2. Go to [Advanced](#) > [System](#) > [Administration](#) and focus on the [Change Password](#) section.

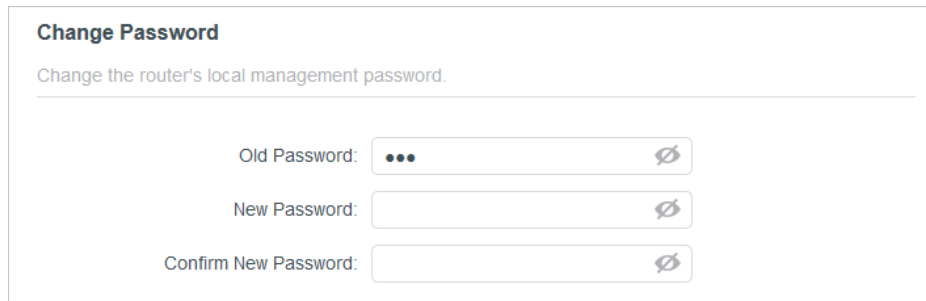

The screenshot shows a web form titled "Change Password". Below the title is a subtitle: "Change the router's local management password." There are three input fields, each with a toggle icon on the right. The first field is labeled "Old Password:" and contains three dots. The second field is labeled "New Password:". The third field is labeled "Confirm New Password:".

3. Enter the old password, then a new password twice (both case-sensitive). Click [SAVE](#).
4. Use the new password for future logins.

## 12.4. Local Management

This feature allows you to limit the number of client devices on your LAN from accessing the router by using the MAC address-based authentication.

1. Visit <http://tplinkwifi.net>, and log in with your TP-Link ID or the password you set for the router.
2. Go to [Advanced](#) > [System](#) > [Administration](#) and complete the settings in [Local Management](#) section as needed.

- **Allow all LAN connected devices to manage the router:**

Select [All Devices](#) for [Local Managers](#).

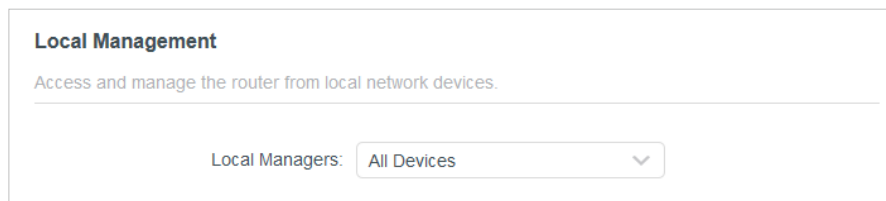

The screenshot shows a web form titled "Local Management". Below the title is a subtitle: "Access and manage the router from local network devices." There is one dropdown menu labeled "Local Managers:" with the value "All Devices" selected.

- **Allow specific devices to manage the router:**
1. Select [All Devices](#) for [Local Managers](#) and click [SAVE](#).

**Local Management**

Access and manage the router from local network devices.

---

Local Managers: Specified Devices + Add Device

Description	MAC Address	Operation
No Entries in this table.		

2. Click [Add Device](#).

Add Device
×

Description:

[VIEW CONNECTED DEVICES](#)

MAC Address:

CANCEL
SAVE

3. Click [VIEW CONNECTED DEVICES](#) and select the device to manage the router from the Connected Devices list, or enter the MAC address of the device manually.

4. Specify a [Description](#) for this entry.

5. Click [SAVE](#).

## 12.5. Remote Management

This feature allows you to control remote devices' authority to manage the router.

1. Visit <http://tplinkwifi.net>, and log in with your TP-Link ID or the password you set for the router.

2. Go to [Advanced](#) > [System](#) > [Administration](#) and complete the settings in [Remote Management](#) section as needed.

- **Forbid all devices to manage the router remotely:**

Do not tick the [Enable](#) checkbox of [Remote Management](#).

### Remote Management

Access and manage the router over the internet.

---

**Note:** Remote Management is not supported when you are connected to the internet only via IPv6. If you want to use Remote Management, please make sure you have set up an IPv4 connection first.

Remote Management:  Enable

- **Allow all devices to manage the router remotely:**

### Remote Management

Access and manage the router over the internet.

---

**Note:** Remote Management is not supported when you are connected to the internet only via IPv6. If you want to use Remote Management, please make sure you have set up an IPv4 connection first.

Remote Management:  Enable

HTTP Port:

Web Address for Management: 0.0.0.0

Remote Managers:

1. Tick the **Enable** checkbox of **Remote Management**.
2. Keep the HTTP port as default settings (recommended) or enter a value between 1024 and 65535.
3. Select **All Devices** for **Remote Managers**.
4. Click **SAVE**.

Devices on the internet can log in to <http://Router's WAN IP address:port number> (such as <http://113.116.60.229:1024>) to manage the router.

 **Tips:**

- You can find the WAN IP address of the router on [Network Map > Internet](#).
  - The router's WAN IP is usually a dynamic IP. Please refer to [Set Up a Dynamic DNS Service Account](#), if you want to log in to the router through a domain name.
- **Allow a specific device to manage the router remotely:**

### Remote Management

Access and manage the router over the internet.

**Note:** Remote Management is not supported when you are connected to the internet only via IPv6. If you want to use Remote Management, please make sure you have set up an IPv4 connection first.

Remote Management:  Enable

HTTP Port:

Web Address for Management: 0.0.0.0

Remote Managers:

Only this IP Address:

1. Tick the **Enable** checkbox of **Remote Management**.
2. Keep the HTTP port as default settings (recommended) or enter a value between 1024 and 65535.
3. Select **Specified Device** for **Remote Managers**.
4. In the **Only this IP Address** field, enter the IP address of the remote device to manage the router.
5. Click **SAVE**.

Devices using this WAN IP can manage the router by logging in to <http://Router's WAN IP:port number> (such as <http://113.116.60.229:1024>).

 **Tips:** The router's WAN IP is usually a dynamic IP. Please refer to [Set Up a Dynamic DNS Service Account](#) if you want to log in to the router through a domain name.

## 12.6. View System Log

When the router does not work normally, you can save the system log and send it to the technical support for troubleshooting.

1. Visit <http://tplinkwifi.net>, and log in your TP-Link ID or the password you set for the router.
2. Go to **Advanced > System > System Log**.
3. In the **Save Log** section, click **SAVE TO LOCAL** to save the system logs to a local disk.

### Save Log

Save system log locally.

## 12.7. Test the Network Connectivity

Diagnostics is used to test the connectivity between the router and the host or other network devices.

1. Visit <http://tplinkwifi.net>, and log in with your TP-Link ID or the password you set for the router.
2. Go to [Advanced](#) > [System](#) > [Diagnostics](#).

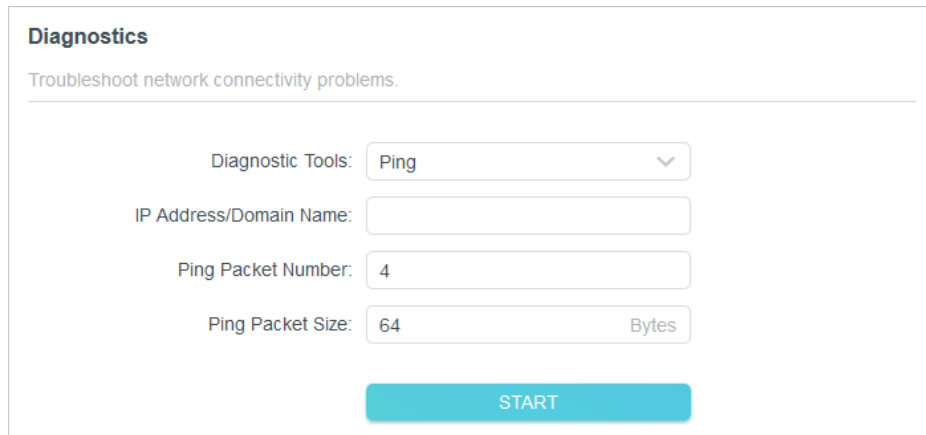

**Diagnostics**  
Troubleshoot network connectivity problems.

Diagnostic Tools:

IP Address/Domain Name:

Ping Packet Number:

Ping Packet Size:  Bytes

**START**

3. Enter the information:

- 1) Choose [Ping](#) or [Tracert](#) as the diagnostic tool to test the connectivity;
  - [Ping](#) is used to test the connectivity between the router and the tested host, and measure the round-trip time.
  - [Tracert](#) is used to display the route (path) your router has passed to reach the tested host, and measure transit delays of packets across an Internet Protocol network.
- 2) Enter the [IP Address](#) or [Domain Name](#) of the tested host.
- 3) Modify the [Ping Packet Number](#) and the [Ping Packet Size](#). It's recommended to keep the default value.
- 4) If you have chosen [Tracert](#), you can modify the [Traceroute Max TTL](#). It's recommended to keep the default value.

4. Click [START](#) to begin the diagnostics.

The figure below indicates the proper connection between the router and the Yahoo server (www.Yahoo.com) tested through [Ping](#).



```

PING 192.168.0.1 (192.168.0.1): 64 data bytes
Reply from 192.168.0.1: bytes=64 ttl=64 seq=1 time=0.322 ms
Reply from 192.168.0.1: bytes=64 ttl=64 seq=2 time=0.308 ms
Reply from 192.168.0.1: bytes=64 ttl=64 seq=3 time=0.286 ms
Reply from 192.168.0.1: bytes=64 ttl=64 seq=4 time=0.334 ms
--- Ping Statistic "192.168.0.1" ---
Packets: Sent=4, Received=4, Lost=0 (0.00% loss)
Round-trip min/avg/max = 0.286/0.312/0.334 ms
ping is stopped.

```

The figure below indicates the proper connection between the router and the Yahoo server (www.Yahoo.com) tested through [Tracert](#).

```

tracert to 192.168.0.1, 5 hops max, 38 byte packets
 1 Archer (192.168.0.1) 0.045 ms 0.015 ms 0.008 ms
Trace Complete.
tracert is stopped.

```

## 12.8. Set Up System Time & Language

The the router's default system language is English. When changed, the router's settings on web management will appear in another language.

System time is the time displayed while the router is running. The system time you configure here will be used for other time-based functions like Parental Controls. You can choose the way to obtain the system time as needed.

1. Visit <http://tplinkwifi.net>, and log in with your TP-Link ID or the password you set for the router.
  2. Go to [Advanced](#) > [System](#) > [Time & Language](#).
- **To change system language:**
    1. Select the language from the drop-down list.
    2. Click [SAVE](#).

**Language**

Set the router's system language.

---

Language: English ▼

- **To get time from the internet:**

1. Enable [24-Hour Time](#) if you want the time to display in a 24-hour way.
2. In the [Set Time](#) field, select [Get from Internet](#).

**System Time**

Set the router's system time.

---

Current Time: 2019-09-17 17:56:00

24-Hour Time:

Set Time:

Time Zone:

NTP Server I:

NTP Server II:  (Optional)

3. Select your local [Time Zone](#) from the drop-down list.
4. In the [NTP Server I](#) field, enter the IP address or domain name of your desired NTP Server.
5. (Optional) In the [NTP Server II](#) field, enter the IP address or domain name of the second NTP Server.
6. Click [SAVE](#).

- **To get time from your computer:**

1. In the [Set Time](#) field, select [Get from Managing Device](#).

**System Time**

Set the router's system time.

---

Current Time: 2019-09-17 17:56:57

24-Hour Time:

Set Time:

2. The time of your computer will then be displayed and click [SAVE](#).

- **To manually set the date and time:**

1. In the [Set Time](#) field, select [Manually](#).

### System Time

Set the router's system time.

Current Time: 2019-09-17 17:57:35

24-Hour Time:

Set Time:

Date:

Time:  :  :

2. Set the current **Date** (In **MM/DD/YYYY** format).
3. Set the current **Time** (In **HH/MM/SS** format).
4. Click **SAVE**.

- **To set up Daylight Saving Time:**

1. Tick the **Enable** box of **Daylight Saving Time**.

### Daylight Saving Time

Automatically synchronize the system time with daylight saving time.

Daylight Saving Time:  Enable

Start:2019

End:2019

Running Status: Daylight Saving Time is on.

2. Select the correct **Start** date and time when daylight saving time starts at your local time zone.
3. Select the correct **End** date and time when daylight saving time ends at your local time zone.
4. Click **SAVE**.

## 12.9. Set the Router to Reboot Regularly

The Scheduled Reboot feature cleans the cache to enhance the running performance of the router.

1. Visit <http://tplinkwifi.net>, and log in with your TP-Link ID or the password you set for the router.

2. Go to [Advanced](#) > [System](#) > [Reboot](#).
3. Tick the [Enable](#) box of [Reboot Schedule](#).

### Reboot Schedule

Set when and how often the router reboots automatically.

---

**Reboot Schedule:**  Enable

**Note:** Make sure [Time Settings](#) are correct before using this function.

**Current Time:** 2019-09-17 17:58:20

Reboot Time:  :

Repeat:

4. Specify the [Reboot Time](#) when the router reboots and [Repeat](#) to decide how often it reboots.
5. Click [SAVE](#).

## 12. 10. Control the LED

The LED of the router indicates its activities and status. You can enable the Night Mode feature to specify a time period during which the LED is off.

1. Visit <http://tplinkwifi.net>, and log in with your TP-Link ID or the password you set for the router.
2. Go to [Advanced](#) > [System](#) > [LED Control](#).
3. Enable [Night Mode](#).

### LED Control

Turn the router's LEDs on or off.

---

LED Status:

### Night Mode

Set a time period when the LEDs will be off automatically.

---

**Night Mode:**  Enable

**Note:** Make sure [Time Settings](#) are correct before using this function.

**Current Time:** 2019-09-02 21:47:24

LED Off From:  :

To:  :  (next day)

4. Specify the LED off time, and the LED will be off during this period every day.
5. Click [SAVE](#).

# FAQ

## Q1. What should I do if I forget my wireless password?

The default wireless password is printed on the label of the router. If the password has been altered:

1. Connect your computer to the router using an Ethernet cable.
2. Visit <http://tplinkwifi.net>, and log in with your TP-Link ID or the password you set for the router.
3. Go to [Wireless](#) to retrieve or reset your wireless password.

## Q2. What should I do if I forget my web management password?

- If you are using a TP-Link ID to log in, click [Forgot password](#) on the login page and then follow the instructions to reset it.
- Alternatively, press and hold the [Reset](#) button of the router until LEDs turn on to reset it, and then visit <http://tplinkwifi.net> to create a new login password.

### Note:

- You'll need to reconfigure the router to surf the internet once the router is reset, and please mark down your new password for future use.

## Q3. What should I do if I can't log in to the router's web management page?

This can happen for a variety of reasons. Please try the methods below to log in again.

- Make sure your computer is connected to the router correctly and the corresponding LED indicator(s) light up.
- Make sure the IP address of your computer is configured as [Obtain an IP address automatically](#) and [Obtain DNS server address automatically](#).
- Make sure <http://tplinkwifi.net> or <http://192.168.0.1> is correctly entered.
- Check your computer's settings:
  - 1) Go to [Start > Control Panel > Network and Internet](#), and click [View network status and tasks](#).
  - 2) Click [Internet Options](#) on the bottom left.
  - 3) Click [Connections](#) and select [Never dial a connection](#).

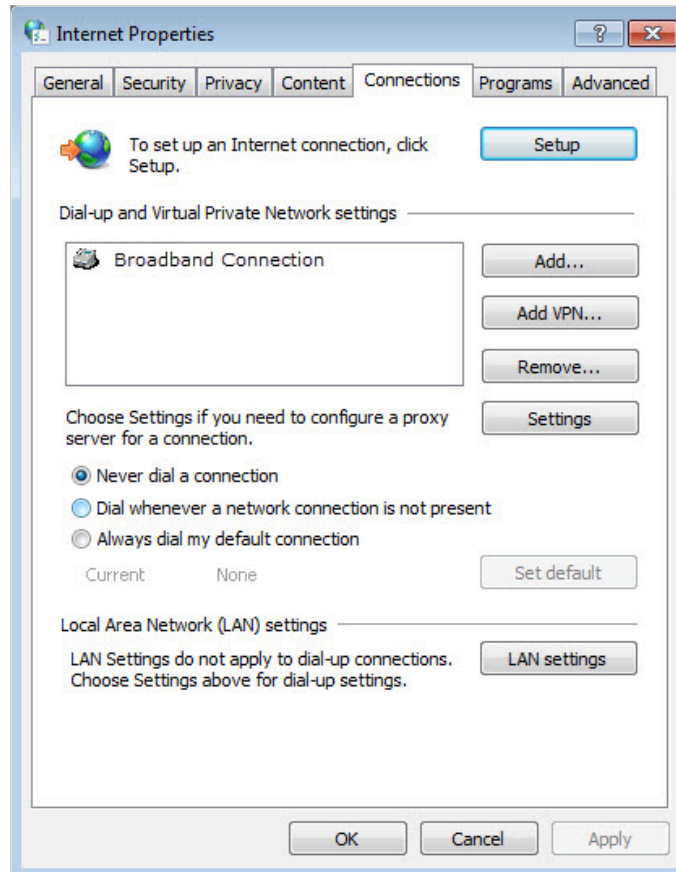

4) Click [LAN settings](#) and deselect the following three options and click [OK](#).

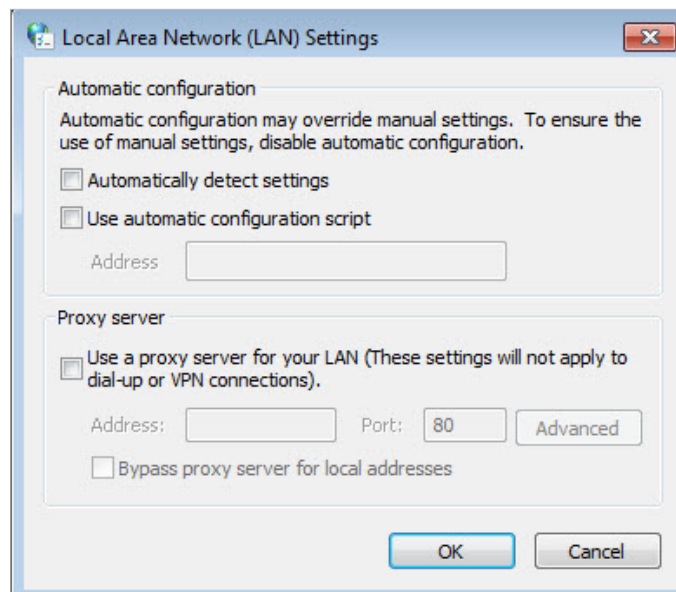

5) Go to [Advanced](#) > [Restore advanced settings](#), click [OK](#) to save the settings.

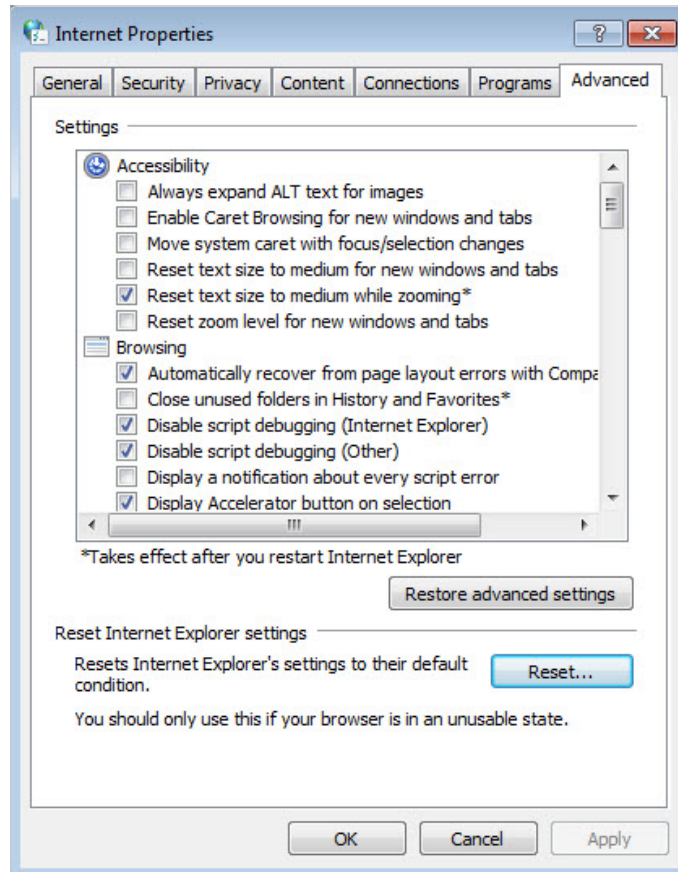

- Use another web browser or computer to log in again.
- Reset the router to factory default settings and try again. If login still fails, please contact the technical support.

ⓘ Note: You'll need to reconfigure the router to surf the internet once the router is reset.

#### Q4. What should I do if I can't access the internet even though the configuration is finished?

1. Visit <http://tplinkwifi.net>, and log in with your TP-Link ID or the password you set for the router.
2. Go to **Advanced > Network > Status** to check internet status:

**If IP Address is a valid one, please try the methods below and try again:**

- Your computer might not recognize any DNS server addresses. Please manually configure the DNS server.
  - 1) Go to **Advanced > Network > DHCP Server**.
  - 2) Enter 8.8.8.8 as Primary DNS, click **SAVE**.

💡 Tips: 8.8.8.8 is a safe and public DNS server operated by Google.



**DHCP Server**  
Dynamically assign IP addresses to the devices connected to the router.

**DHCP Server:**  Enable

IP Address Pool:  -

Address Lease Time:  minutes

Default Gateway:  (Optional)

Primary DNS:  (Optional)

Secondary DNS:  (Optional)

- Restart the modem and the router.
  - 1) Power off your modem and router, and leave them off for 1 minute.
  - 2) Power on your modem first, and wait about 2 minutes until it gets a solid cable or Internet light.
  - 3) Power on the router.
  - 4) Wait another 1 or 2 minutes and check the internet access.
- Reset the router to factory default settings and reconfigure the router.
- Upgrade the firmware of the router.
- Check the TCP/IP settings on the particular device if all other devices can get internet from the router.

**As the picture below shows, if the IP Address is 0.0.0.0, please try the methods below and try again:**

**Status**  
Internet status overview is displayed on this page.

**Internet**

Status: WAN port is unplugged

Internet Connection Type: Dynamic IP

IP Address: 0.0.0.0

Subnet Mask: 0.0.0.0

Default Gateway: 0.0.0.0

Primary DNS: 0.0.0.0

Secondary DNS: 0.0.0.0

- Make sure the physical connection between the router and the modem is proper.
- Clone the MAC address of your computer.

- 1) Visit <http://tplinkwifi.net>, and log in with your TP-Link ID or the password you set for the router.
- 2) Go to [Internet](#) or [Advanced](#) > [Network](#) > [Internet](#) and focus on the [MAC Clone](#) section.
- 3) Choose an option as needed (enter the MAC address if [Use Custom MAC Address](#) is selected), and click [SAVE](#).

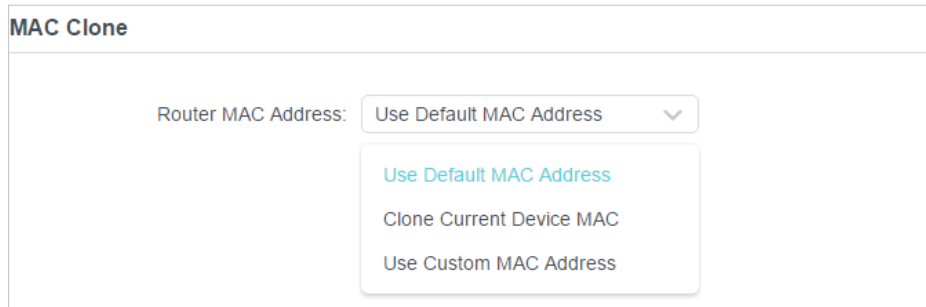

 **Tips:**

- Some ISP will register the MAC address of your computer when you access the internet for the first time through their Cable modem, if you add a router into your network to share your internet connection, the ISP will not accept it as the MAC address is changed, so we need to clone your computer's MAC address to the router.
- The MAC addresses of a computer in wired connection and wireless connection are different.

- **Modify the LAN IP address of the router.**

 **Note:**

Most TP-Link routers use 192.168.0.1/192.168.1.1 as their default LAN IP address, which may conflict with the IP range of your existing ADSL modem/router. If so, the router is not able to communicate with your modem and you can't access the internet. To resolve this problem, we need to change the LAN IP address of the router to avoid such conflict, for example, 192.168.2.1.

- 1) Visit <http://tplinkwifi.net>, and log in with your TP-Link ID or the password you set for the router.
- 2) Go to [Advanced](#) > [Network](#) > [LAN](#).
- 3) Modify the LAN IP address as the follow picture shows. Here we take 192.168.2.1 as an example.
- 4) Click [Save](#).

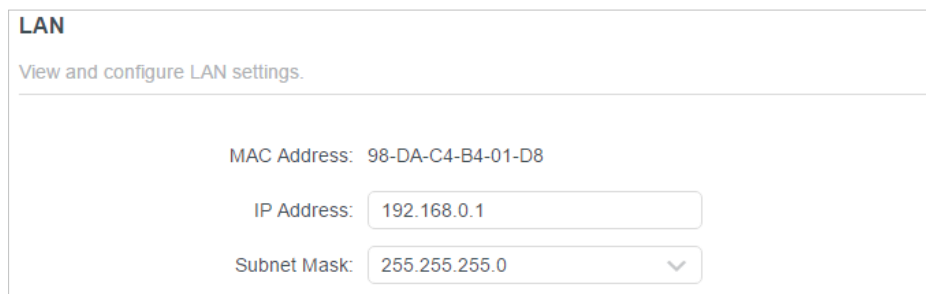

- **Restart the modem and the router.**

- 1) Power off your modem and router, and leave them off for 1 minute.
  - 2) Power on your modem first, and wait about 2 minutes until it get a solid cable or Internet light.
  - 3) Power on the router.
  - 4) Wait another 1 or 2 minutes and check the internet access.
- Double check the internet connection type.
    - 1) Confirm your internet connection type, which can be learned from the ISP.
    - 2) Visit <http://tplinkwifi.net>, and log in with your TP-Link ID or the password you set for the router.
    - 3) Go to [Advanced](#) > [Network](#) > [Internet](#).
    - 4) Select your [Internet Connection Type](#) and fill in other parameters.
    - 5) Click [Save](#).

**Internet**

Set up an internet connection with the service information provided by your ISP (internet service provider).

---

Internet Connection Type: Dynamic IP ▼

IP Address: Static IP

Subnet Mask: Dynamic IP

Default Gateway: PPPoE

Primary DNS: L2TP

Secondary DNS: PPTP

Secondary DNS: 0.0.0.0

RENEW  
RELEASE

- 6) Restart the modem and the router again.
- Please upgrade the firmware of the router.
- If you've tried every method above but still cannot access the internet, please contact the technical support.

**Q5.What should I do if I can't find my wireless network or I cannot connect the wireless network?**

**If you fail to find any wireless network, please follow the steps below:**

- Make sure the wireless function of your device is enabled if you're using a laptop with built-in wireless adapter. You can refer to the relevant document or contact the laptop manufacturer.

- Make sure the wireless adapter driver is installed successfully and the wireless adapter is enabled.

- **On Windows 7**

- 1) If you see the message [No connections are available](#), it is usually because the wireless function is disabled or blocked somehow.
- 2) Click [Troubleshoot](#) and windows might be able to fix the problem by itself.

- **On Windows XP**

- 1) If you see the message [Windows cannot configure this wireless connection](#), this is usually because windows configuration utility is disabled or you are running another wireless configuration tool to connect the wireless.
- 2) Exit the wireless configuration tool (the TP-Link Utility, for example).
- 3) Select and right click on [My Computer](#) on desktop, select [Manage](#) to open Computer Management window.
- 4) Expand [Services and Applications](#) > [Services](#), find and locate [Wireless Zero Configuration](#) in the Services list on the right side.
- 5) Right click [Wireless Zero Configuration](#), and then select [Properties](#).
- 6) Change [Startup type](#) to [Automatic](#), click on Start button and make sure the Service status is [Started](#). And then click [OK](#).

**If you can find other wireless network except your own, please follow the steps below:**

- Check the WLAN LED indicator on your wireless router/modem.
- Make sure your computer/device is still in the range of your router/modem. Move it closer if it is currently too far away.
- Go to [Wireless](#) or [Advanced](#) > [Wireless](#) > [Wireless Settings](#), and check the wireless settings. Double check your wireless Network Name and SSID is not hidid.

**Wireless Settings**

Personalize settings for each band or enable Smart Connect to configure the same settings for all bands.

---

**Smart Connect:**  Enable ? Sharing Network

**2.4GHz:**  Enable Sharing Network

Network Name (SSID):   Hide SSID

Security:  ▼

Password:

**5GHz:**  Enable Sharing Network

Network Name (SSID):   Hide SSID

Security:  ▼

Password:

If you can find your wireless network but fail to connect, please follow the steps below:

- **Authenticating problem/password mismatch:**

- 1) Sometimes you will be asked to type in a PIN number when you connect to the wireless network for the first time. This PIN number is different from the Wireless Password/Network Security Key, usually you can only find it on the label of your router.



- 2) If you cannot find the PIN or PIN failed, you may choose [Connecting using a security key instead](#), and then type in the [Wireless Password/Network Security Key](#).
- 3) If it continues to show note of [Network Security Key Mismatch](#), it is suggested to confirm the wireless password of your wireless router.

■ Note: Wireless Password/Network Security Key is case sensitive.

- **Windows unable to connect to XXXX / Can not join this network / Taking longer than usual to connect to this network:**

- Check the wireless signal strength of your network. If it is weak (1~3 bars), please move the router closer and try again.
- Change the wireless Channel of the router to 1, 6 or 11 to reduce interference from other networks.
- Re-install or update the driver for your wireless adapter of the computer.

## COPYRIGHT & TRADEMARKS

Specifications are subject to change without notice.  tp-link is a registered trademark of TP-Link Technologies Co., Ltd. Other brands and product names are trademarks or registered trademarks of their respective holders.

App store is a service mark of Apple Inc. Google is a trademark of Google LLC.

No part of the specifications may be reproduced in any form or by any means or used to make any derivative such as translation, transformation, or adaptation without permission from TP-Link Technologies Co., Ltd. Copyright © 2020 TP-Link Technologies Co., Ltd. All rights reserved.

## FCC compliance information statement



**Product Name:** AC1900 MU-MIMO Wi-Fi Router

**Model Number:** Archer A8

Component Name	Model
I.T.E. Power	T120150-2B1

### **Responsible party:**

TP-Link USA Corporation, d/b/a TP-Link North America, Inc.

Address: 145 South State College Blvd. Suite 400, Brea, CA 92821

Website: <http://www.tp-link.com/us/>

Tel: +1 626 333 0234

Fax: +1 909 527 6803

E-mail: [sales.usa@tp-link.com](mailto:sales.usa@tp-link.com)

This equipment has been tested and found to comply with the limits for a Class B digital device, pursuant to part 15 of the FCC Rules. These limits are designed to provide reasonable protection against harmful interference in a residential installation. This equipment generates, uses and can radiate radio frequency energy and, if not installed and used in accordance with the instructions, may cause harmful interference to radio communications. However, there is no guarantee that interference will not occur in a particular installation. If this equipment does cause harmful interference to radio or television reception, which can be determined by turning the equipment off and on, the user is encouraged to try to correct the interference by one or more of the following measures:

- Reorient or relocate the receiving antenna.
- Increase the separation between the equipment and receiver.
- Connect the equipment into an outlet on a circuit different from that to which the receiver is connected.
- Consult the dealer or an experienced radio/ TV technician for help.

This device complies with part 15 of the FCC Rules. Operation is subject to the following two conditions:

1. This device may not cause harmful interference.
2. This device must accept any interference received, including interference that may cause undesired operation.

Any changes or modifications not expressly approved by the party responsible for compliance could void the user's authority to operate the equipment.



Note: The manufacturer is not responsible for any radio or TV interference caused by unauthorized modifications to this equipment. Such modifications could void the user's authority to operate the equipment.

### **FCC RF Radiation Exposure Statement**

This equipment complies with FCC RF radiation exposure limits set forth for an uncontrolled environment. This device and its antenna must not be co-located or operating in conjunction with any other antenna or transmitter.

"To comply with FCC RF exposure compliance requirements, this grant is applicable to only Mobile Configurations. The antennas used for this transmitter must be installed to provide a separation distance of at least 20 cm from all persons and must not be co-located or operating in conjunction with any other antenna or transmitter."

We, **TP-Link USA Corporation**, has determined that the equipment shown as above has been shown to comply with the applicable technical standards, FCC part 15. There is no unauthorized change is made in the equipment and the equipment is properly maintained and operated.

Issue Date: 2020-03-17

### **FCC compliance information statement**

Product Name: I.T.E. Power Supply

Model Number: T120150-2B1

Responsible party:

TP-Link USA Corporation, d/b/a TP-Link North America, Inc.

Address: 145 South State College Blvd. Suite 400, Brea, CA 92821

Website: <http://www.tp-link.com/us/>

Tel: +1 626 333 0234

Fax: +1 909 527 6803

E-mail: [sales.usa@tp-link.com](mailto:sales.usa@tp-link.com)

This equipment has been tested and found to comply with the limits for a Class B digital device, pursuant to part 15 of the FCC Rules. These limits are designed to provide reasonable protection against harmful interference in a residential installation. This equipment generates, uses and can radiate radio frequency energy and, if not installed and used in accordance with the instructions, may cause harmful interference to radio communications. However, there is no guarantee that interference will not occur in a particular installation. If this equipment does cause harmful interference to radio or television reception, which can be determined by turning the equipment off and on, the user is encouraged to try to correct the interference by one or more of the following measures:

- Reorient or relocate the receiving antenna.

- Increase the separation between the equipment and receiver.
- Connect the equipment into an outlet on a circuit different from that to which the receiver is connected.
- Consult the dealer or an experienced radio/ TV technician for help.

This device complies with part 15 of the FCC Rules. Operation is subject to the following two conditions:

1. This device may not cause harmful interference.
2. This device must accept any interference received, including interference that may cause undesired operation.

Any changes or modifications not expressly approved by the party responsible for compliance could void the user's authority to operate the equipment.

We, **TP-Link USA Corporation**, has determined that the equipment shown as above has been shown to comply with the applicable technical standards, FCC part 15. There is no unauthorized change is made in the equipment and the equipment is properly maintained and operated.

Issue Date: 2020-03-17

## CE Mark Warning



This is a class B product. In a domestic environment, this product may cause radio interference, in which case the user may be required to take adequate measures.

## OPERATING FREQUENCY (the maximum transmitted power)

2400 MHz -2483.5 MHz(20dBm)

5150 MHz -5250 MHz(23dBm)

## EU declaration of conformity

TP-Link hereby declares that the device is in compliance with the essential requirements and other relevant provisions of directives 2014/53/EU, 2009/125/EC, 2011/65/EU and (EU)2015/863.

The original EU declaration of conformity may be found at

<https://www.tp-link.com/en/ce>

## RF Exposure Information

This device meets the EU requirements (2014/53/EU Article 3.1a) on the limitation of exposure of the general public to electromagnetic fields by way of health protection.

The device complies with RF specifications when the device used at 20 cm from your body.

## National restrictions

Attention: This device may only be used indoors in all EU member states and EFTA countries.

	AT	BE	BG	CH	CY	CZ	DE	DK
	EE	EL	ES	FI	FR	HR	HU	IE
	IS	IT	LI	LT	LU	LV	MT	NL
	NO	PL	PT	RO	SE	SI	SK	UK

## Canadian Compliance Statement

This device contains licence-exempt transmitter(s)/receiver(s) that comply with Innovation, Science and Economic Development Canada's licence-exempt RSS(s). Operation is subject to the following two conditions:

1. This device may not cause interference.
2. This device must accept any interference, including interference that may cause undesired operation of the device.

L'émetteur/récepteur exempt de licence contenu dans le présent appareil est conforme aux CNR d'Innovation, Sciences et Développement économique Canada applicables aux appareils radio exempts de licence. L'exploitation est autorisée aux deux conditions suivantes :

1. l'appareil ne doit pas produire de brouillage;
2. l'utilisateur de l'appareil doit accepter tout brouillage radioélectrique subi, même si le brouillage est susceptible d'en compromettre le fonctionnement

### **Caution:**

The device for operation in the band 5150–5250 MHz is only for indoor use to reduce the potential for harmful interference to co-channel mobile satellite systems;

### **Avertissement:**

Le dispositif fonctionnant dans la bande 5150-5250 MHz est réservé uniquement pour une utilisation à l'intérieur afin de réduire les risques de brouillage préjudiciable aux systèmes de satellites mobiles utilisant les mêmes canaux;

### **Radiation Exposure Statement:**

This equipment complies with IC radiation exposure limits set forth for an uncontrolled environment. This equipment should be installed and operated with minimum distance 20cm between the radiator & your body.

### **Déclaration d'exposition aux radiations:**

Cet équipement est conforme aux limites d'exposition aux rayonnements IC établies pour un environnement non contrôlé. Cet équipement doit être installé et utilisé avec un minimum de 20 cm de distance entre la source de rayonnement et votre corps.

### **Industry Canada Statement**

CAN ICES-3 (B)/NMB-3(B)

### **Korea Warning Statements:**

당해 무선설비는 운용중 전파혼신 가능성이 있음.

### **NCC Notice & BSMI Notice:**

注意!

依據 低功率電波輻射性電機管理辦法

第十二條 經型式認證合格之低功率射頻電機，非經許可，公司、商號或使用者均不得擅自變更頻率、加大功率或變更原設計之特性或功能。

第十四條 低功率射頻電機之使用不得影響飛航安全及干擾合法通信；經發現有干擾現象時，應立即停用，並改善至無干擾時方得繼續使用。前項合法通信，指依電信規定作業之無線電信。低功率射頻電機需忍受合法通信或工業、科學以及醫療用電波輻射性電機設備之干擾。

4.7.9.1 應避免影響附近雷達系統之操作。

4.7.9.2 高增益指向性天線只得應用於固定式點對點系統。

### 安全諮詢及注意事項

- 請使用原裝電源供應器或只能按照本產品注明的電源類型使用本產品。
- 清潔本產品之前請先拔掉電源線。請勿使用液體、噴霧清潔劑或濕布進行清潔。
- 注意防潮，請勿將水或其他液體潑灑到本產品上。
- 插槽與開口供通風使用，以確保本產品的操作可靠並防止過熱，請勿堵塞或覆蓋開口。
- 請勿將本產品置放於靠近熱源的地方。除非有正常的通風，否則不可放在密閉位置中。
- 請不要私自打開機殼，不要嘗試自行維修本產品，請由授權的專業人士進行此項工作。

### 限用物質含有情況標示聲明書

產品元件名稱	限用物質及其化學符號					
	鉛 Pb	鎘 Cd	汞 Hg	六價鉻 CrVI	多溴聯苯 PBB	多溴二苯醚 PBDE
PCB	○	○	○	○	○	○
外殼	○	○	○	○	○	○
電源供應器	-	○	○	○	○	○

備考1. 超出0.1 wt %” 及 “超出0.01 wt %” 系指限用物質之百分比含量超出百分比含量基準值。

備考2. “○” 系指該項限用物質之百分比含量未超出百分比含量基準值。

備考3. “-” 系指該項限用物質為排除項目。



Продукт сертифіковано згідно с правилами системи УкрСЕПРО на відповідність вимогам нормативних документів та вимогам, що передбачені чинними законодавчими актами України.



## Safety Information







- Keep the device away from water, fire, humidity or hot environments.
- Do not attempt to disassemble, repair, or modify the device. If you need service, please contact us.
- Do not use damaged charger or USB cable to charge the device.
- Do not use any other chargers than those recommended
- Do not use the device where wireless devices are not allowed.
- Adapter shall be installed near the equipment and shall be easily accessible.
-  Use only power supplies which are provided by manufacturer and in the original packing of this product. If you have any questions, please don't hesitate to contact us.

Please read and follow the above safety information when operating the device. We cannot guarantee that no accidents or damage will occur due to improper use of the device. Please use this product with care and operate at your own risk.

## Environment

- Operating Temperature: 0°C~40°C (32°F ~104°F)
- Storage Temperature: -40°C~70°C (-40°F ~158°F)
- Operating Humidity: 10%~90% non-condensing
- Storage Humidity: 5%~90% non-condensing

## Explanations of the symbols on the product label

Symbol	Explanation
	Class II equipment
	AC voltage
	DC voltage
	Polarity of output terminals
	Indoor use only
	Energy efficiency Marking
	<b>RECYCLING</b> This product bears the selective sorting symbol for Waste electrical and electronic equipment (WEEE). This means that this product must be handled pursuant to European directive 2012/19/EU in order to be recycled or dismantled to minimize its impact on the environment. User has the choice to give his product to a competent recycling organization or to the retailer when he buys a new electrical or electronic equipment.

